

cilio

Katalog 2019 / 2020

Mein
kleines Italien
zuhause



Willkommen
in der
Markenwelt
von
cilio

Mein
kleines Italien
zu Hause

Welcome
in the
brand world
of
cilio

My
little Italy
at home







KAFFEEWELT

SEITE 8 – 43

WORLD OF COFFEE



Prendiamo un caffè

Alles für den perfekten Kaffeegenuss

Everything for the perfect coffee enjoyment

ISOLIEREN

SEITE 44 – 51

HOT AND COLD



Caldo e freddo

Alles für heiße und kalte Getränke und Speisen zuhause und unterwegs

Everything for hot and cold beverages and food at home and to go

WÜRZEN

SEITE 52 – 58

SEASONING



Le spezie

Alles für ein herausragendes Geschmackserlebnis

Everything for outstanding taste experience

SERVIEREN AM TISCH

SEITE 59 – 63

SERVING AT THE TABLE

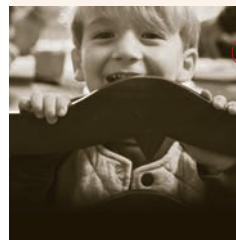

Trattoria da mamma

Alles rund um den gedeckten Tisch

Everything around the well-laid table

FORMAGGIO

SEITE 64 – 69

FORMAGGIO



Formaggio

Alles zum Servieren rund um den Käse

Everything around serving cheese

ZUHAUSE GENIEßEN

SEITE 70 – 77

ENJOY AT HOME



Tavola e cucina

Praktisches für Küche und Haushalt

Useful utensiles for kitchen and household

ELEKTRO

SEITE 78 – 82

ELECTRIC



Elettrico

Kleine Haushaltsgeräte für den Alltag und Highlights für besondere Momente

Small household appliances for everyday and highlights for special moments

BAR UND WEIN

SEITE 83 – 104

BAR AND WINE



Salute!

Die feine Welt der Bar- und Weinkultur

The exquisite world of bar and wine culture

OUTDOOR

SEITE 105 – 115

OUTDOOR



Per fuori

Alles für draußen und unterwegs
Everything for outdoor and to go

SCHÖNES UND NÜTZLICHES

SEITE 116 – 121

NICE AND USEFUL



Bella e utile

Kleine Geschenke und alles für ein gemütliches zuhause

Small gifts and everything cosy home

KONTAKT | CONTACT

SEITE 122 – 123

INHALT | CONTENT

SEITE 124 – 127

Wissenswertes / worth knowing



1 Den Kocher aufschrauben, gewünschte Wassermenge bis maximal kurz unter das Sicherheitsventil einfüllen. Trichter ins Kocherunterteil einsetzen.

Screw open the boiler and fill it with the desired amount of water until the water level almost reaches the safety valve. Insert the funnel into the lower part.



2 Pro Tasse 1 Messlöffel (ca. 7 gr.) Espressopulver in den Trichter füllen, glatt streichen, jedoch nicht zu fest andrücken.

Fill the funnel with 1 measuring spoon (approx. 7 g) of espresso powder per cup and level the powder without compacting it too much.



3 Den Rand des Trichters säubern. Den Kocher fest zusammenschrauben, Deckel schließen und auf mittlerer Stufe des Herdes erhitzen.

Clean the rim of the strainer. Screw the coffee maker firmly together, close the lid and heat up the boiler on your stove at maximum heat.



4 Der Espresso ist fertig, sobald das leise Blubbern zu hören ist. Kocher vom Herd nehmen. Fließt kein Espresso mehr aus dem Steigrohr, den Kaffee umrühren.

Remove the coffee maker from the stove when you start hearing a soft bubbling noise. Stir the coffee as soon as no more espresso is flowing through the riser tube.



5 Den Espresso in vorgewärmten Tassen sofort servieren. Zucker dazu reichen.

Fill the espresso into pre-heated cups and serve immediately. Serve with sugar.



6 Den abgekühlten Kocher auseinander schrauben, Trichter vorsichtig leeren. Alles mit warmen Wasser und Spülmittel reinigen. Offen trocknen lassen.

When the coffee maker has cooled down, unscrew it and carefully empty the funnel. Clean all components using warm water and dish detergent. Leave parts open to dry.

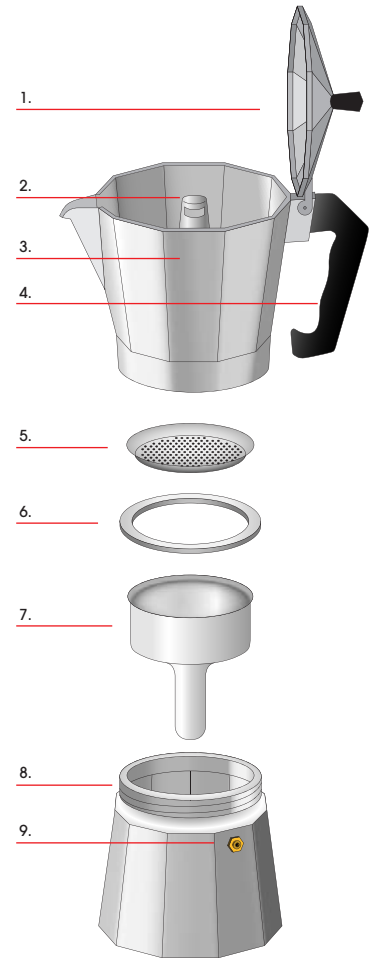

- | | |
|---------------------------|----------------------|
| 1. Deckel mit Deckelknopf | 6. Dichtungsring |
| 2. Steigrohr | 7. Trichter |
| 3. Kaffeebehälter | 8. Unterteil |
| 4. Griff | 9. Sicherheitsventil |
| 5. Sieb | |
| 1. Lid with knob | 6. Gasket |
| 2. Riser tube | 7. Funnel |
| 3. Coffee jug | 8. Lower part |
| 4. Handle | 9. Safety valve |
| 5. Sieve | |

Erhitzen Sie den Espresso-Kocher nur auf mittlerer Stufe.

Aus technischen Gründen ist es möglich, dass ein kleiner Rest Wasser im Unterteil verbleiben kann. Nehmen Sie den Kocher vom Herd, sobald das leise Blubbern zu hören ist. Dadurch verhindern Sie ein unbeabsichtigtes Leerkochen. Falls der Kaffee zu fein gemahlen wird, kann es passieren, dass etwas Kaffeepulver in das Unterteil gelangen kann.

Im Laufe des Gebrauchs kann der Dichtungsring unter Umständen spröde und damit undicht werden und sollte dann ausgetauscht werden. Zu den cilio Espresso-Kochern sind die Dichtungsringe als Ersatzteil erhältlich.

Only heat the coffee maker at medium level. Due to technical reasons a little amount of water might remain in the lower part. Remove the coffee maker from the stove as soon as the quiet gurgling sounds. This prevents from boiling dry accidentally.

If the coffee powder is ground too finely, it might happen that a little amount gets into the lower part.

In the course of use the gasket could possibly become brittle and leaky and should be replaced then. For the cilio espresso makers gaskets are available as spare part.

ESPRESSOKOCHER CLASSICO

Aluminium, mit Planboden

ESPRESSO MAKER CLASSICO. Aluminium, with plane bottom

Art.-Nr.	Inhalt	Ø	Höhe cm	EAN	
320725	1 Tasse	6,5	12,5	4017166320725	
320602	3 Tassen	8,5	16	4017166320602	
320619	6 Tassen	9	20	4017166320619	
320626	9 Tassen	10,5	23,5	4017166320626	



ESPRESSOKOCHER CLASSICO

Aluminium, farbig lackiert, mit Planboden, für 6 Tassen

ESPRESSO MAKER CLASSICO. Aluminium, lacquered in color, with plane bottom, for 6 cups

Art.-Nr.	Farbe	Ø	Höhe cm	EAN	
321319	rot/red	9	20	4017166321319	
321326	schwarz/black	9	20	4017166321326	
321395	cool grey	9	20	4017166321395	



ESPRESSOKOCHER CLASSICO

Aluminium, farbig lackiert, mit Planboden, für 6 Tassen

ESPRESSO MAKER CLASSICO. Aluminium, lacquered in color, with plane bottom, for 6 cups

Art.-Nr.	Farbe	Ø	Höhe cm	EAN	
321401	taupe	9	20	4017166321401	
321418	ocean blue	9	20	4017166321418	
321425	berry	9	20	4017166321425	



ESPRESSOKOCHER CLASSICO NATURA

Aluminium, schwarz lackiert, mit Planboden, Griff und Deckelknopf aus hochwertigem Kunststoff in Holzdesign

ESPRESSO MAKER CLASSICO NATURA. Aluminium, black lacquered, with plane bottom, handle and lid knob made of high-quality plastics in wood design

Art.-Nr.	Inhalt	Ø	Höhe cm	EAN	
321371	3 Tassen	9	15	4017166321371	
321388	6 Tassen	10	19	4017166321388	



ESPRESSOKOCHER CLASSICO INDUKTION

Aluminium, mit Planboden, induktionsgeeignete Bodenplatte*

ESPRESSO MAKER CLASSICO. Aluminium, with plane bottom. Also suitable for induction*

Art.-Nr.	Inhalt	Ø	Höhe cm	EAN	
321272	6 Tassen	8,5	19	4017166321272	
321289	9 Tassen	9,5	22,5	4017166321289	



* Induktionsgeeignet abhängig vom Mindestdurchmesser der Topferkennung Ihres Herdes. | Suitable for induction depending on the minimum diameter of your pan detection.



ESPRESSOKOCHER ADRIANA

Edelstahl poliert, mit Planboden, auch für Induktion geeignet*
 ESPRESSO MAKER ADRIANA. Stainless steel mirror polished, with plane bottom.
 Also suitable for induction*

Art.-Nr.	Inhalt	Ø	Höhe cm	EAN	
341300	2 Tassen	8	15	4017166341300	
341317	4 Tassen	8,5	16,5	4017166341317	
341324	6 Tassen	10	19	4017166341324	

ESPRESSOKOCHER VITO

Edelstahl poliert, mit Planboden, auch für Induktion geeignet*
 ESPRESSO MAKER VITO. Stainless steel mirror polished, with plane bottom.
 Also suitable for induction*



Art.-Nr.	Inhalt	Ø	Höhe cm	EAN	
342932	4 Tassen	8,5	17,5	4017166342932	
342949	6 Tassen	9	19,5	4017166342949	

ESPRESSOKOCHER GIOVANNA

Edelstahl poliert, mit Planboden, auch für Induktion geeignet*
 ESPRESSO MAKER GIOVANNA. Stainless steel mirror polished, with plane bottom.
 Also suitable for induction*



Art.-Nr.	Inhalt	Ø	Höhe cm	EAN	
202601	4 Tassen	9	17	4017166202601	
202618	6 Tassen	10	19	4017166202618	

Der perfekte Espresso

Im vielseitigen **cilio** Angebot wählen Sie an formschönen und praktischen Espressokochern je nach Farb-, Design- und Materialwunsch zwischen Aluminium (traditionell) und Edelstahl (modern).

Unsere elektrischen Modelle zaubern die schwarze italienische Köstlichkeit aus Wasser und Kaffeepulver sogar ohne Herdplatte.

The perfect espresso

In the diverse **cilio** assortment of attractive and useful espresso makers, you choose between aluminium (traditional) and stainless steel (modern) in the colour, design and material of your choice.

Our electric models can even conjure up the black Italian delicacy from water and ground coffee without a cooktop.

* Induktionsgeeignet abhängig vom Mindestdurchmesser der Topferkennung Ihres Herdes. | Suitable for induction depending on the minimum diameter of your pan detection.

Produkt in Geschenkverpackung | Product in giftbox = 

ESPRESSOKOCHER RIGOLETTO

Edelstahl poliert, mit Planboden, auch für Induktion geeignet*

ESPRESSO MAKER RIGOLETTO. Stainless steel mirror polished, with plane bottom. Also suitable for induction*

Art.-Nr.	Inhalt	Ø	Höhe cm	EAN	
342321	4 Tassen	9,5	16,5	4017166342321	
342338	6 Tassen	10,5	20	4017166342338	



ESPRESSOKOCHER AIDA

Edelstahl poliert, mit Planboden, auch für Induktion geeignet*

ESPRESSO MAKER AIDA. Stainless steel mirror polished, with plane bottom. Also suitable for induction*

Art.-Nr.	Inhalt	Ø	Höhe cm	EAN	
342239	2 Tassen	9	15	4017166342239	
342048	4 Tassen	9,5	17,5	4017166342048	
342055	6 Tassen	10,5	20,5	4017166342055	
342246	10 Tassen	13	24	4017166342246	



ESPRESSOKOCHER AIDA

Edelstahl satiniert, mit Planboden, auch für Induktion geeignet*

ESPRESSO MAKER AIDA. Stainless steel satin finish, with plane bottom. Also suitable for induction*

Art.-Nr.	Inhalt	Ø	Höhe cm	EAN	
342901	4 Tassen	9,5	17,5	4017166342901	
342918	6 Tassen	10,5	20,5	4017166342918	



„Was der Herd nicht kann, kann der Kocher nicht!“

Unsere **cilio** - Espressokocher aus Edelstahl sowie das Modell CLASSICO INDUKTION sind mit einem magnetischen Planboden ausgestattet, der den Einsatz auf Induktions-Kochfeldern ermöglicht.

Hierbei muss dennoch auf den Mindestdurchmesser der Topferkennung des Herdes geachtet werden. *

„What the stove cannot do, the espresso maker cannot.“

Our **cilio** stainless steel espresso makers and the model CLASSICO INDUKTION are equipped with a magnetic flat bottom, which allows the use on induction cooktops. Nevertheless, attention must be paid to the minimum diameter of the pot detection of the stove.*

* Induktionsgeeignet abhängig vom Mindestdurchmesser der Topferkennung Ihres Herdes. | Suitable for induction depending on the minimum diameter of your pan detection.

Produkt in Geschenkverpackung | Product in giftbox = 



ESPRESSOKOCHER FIGARO

Edelstahl poliert, mit Planboden, auch für Induktion geeignet*

ESPRESSO MAKER FIGARO. Stainless steel mirror polished, with plane bottom. Also suitable for induction*

Art.-Nr.	Inhalt	Ø	Höhe cm	EAN	
342215	2 Tassen	9	17	4017166342215	
342024	4 Tassen	9,5	19	4017166342024	
342031	6 Tassen	10,5	22	4017166342031	
342222	10 Tassen	13	26	4017166342222	



ESPRESSOKOCHER MODENA

Edelstahl poliert, mit Planboden, auch für Induktion geeignet*

ESPRESSO MAKER MODENA. Stainless steel mirror polished, with plane bottom. Also suitable for induction*

Art.-Nr.	Inhalt	Ø	Höhe cm	EAN	
202298	4 Tassen	8	18	4017166202298	
202304	6 Tassen	10,5	21	4017166202304	



ESPRESSOKOCHER TREVISO

Edelstahl poliert, mit Planboden, auch für Induktion geeignet*

ESPRESSO MAKER TREVISO. Stainless steel mirror polished, with plane bottom. Also suitable for induction*

Art.-Nr.	Inhalt	Ø	Höhe cm	EAN	
202113	4 Tassen	8	18	4017166202113	
202120	6 Tassen	10,5	21	4017166202120	



* Induktionsgeeignet abhängig vom Mindestdurchmesser der Topferkennung Ihres Herdes. | Suitable for induction depending on the minimum diameter of your pan detection.

Produkt in Geschenkverpackung | Product in giftbox = 

ESPRESSOKOCHER CAFFETTIERA

Edelstahl poliert, mit Planboden, auch für Induktion geeignet*

ESPRESSO MAKER CAFFETTIERA. Stainless steel mirror polished, with plane bottom. Also suitable for induction

Art.-Nr.	Inhalt	Ø	Höhe cm	EAN	
342970	2 Tassen	8,5	16	4017166342970	



ESPRESSOKOCHER NICOLE

Edelstahl poliert / Porzellan, mit Planboden, auch für Induktion geeignet*

ESPRESSO MAKER NICOLE. Stainless steel mirror polished / porcelain, with plane bottom. Also suitable for induction*

Art.-Nr.	Inhalt	Ø	Höhe cm	EAN	
232516	4 Tassen	8,5	19	4017166232516	



ESPRESSOKOCHER ALADINO

Edelstahl poliert / Porzellan, mit Planboden, auch für Induktion geeignet*

ESPRESSO MAKER ALADINO. Stainless steel mirror polished / porcelain, with plane bottom. Also suitable for induction*

Art.-Nr.	Inhalt	Ø	Höhe cm	EAN	
232646	4 Tassen	10	19	4017166232646	



* Induktionsgeeignet abhängig vom Mindestdurchmesser der Topferkennung Ihres Herdes. | Suitable for induction depending on the minimum diameter of your pan detection.

Produkt in Geschenkverpackung | Product in giftbox = 



ESPRESSOKOCHER CLASSICO

ELEKTRISCH

Aluminium, kabelloser Zentralkontakt 360°, Warmhaltefunktion, Ein-/Ausschalter mit Kontrollleuchte

ESPRESSO MAKER CLASSICO, electric. Aluminium, cordless, 360° degree base, keeping warm function, on/off switch with control lamp, 6 cups

Art.-Nr.	Inhalt	Ø	Höhe cm	EAN	
273700	6 Tassen	11,5	25	4017166273700	

220–240 V | 50 Hz | 480 W

ESPRESSOKOCHER CLASSICO

ELEKTRISCH

Aluminium, farbig lackiert, kabelloser Zentralkontakt 360°, Warmhaltefunktion, Ein-/Ausschalter mit Kontrollleuchte

ESPRESSO MAKER CLASSICO, electric. Aluminium, lacquered in color, cordless, 360° degree base, keeping warm function, on/off switch with control lamp, 6 cups

Art.-Nr.	Farbe	Inhalt	Ø	Höhe cm	EAN	
273854	rot/red	6 Tassen	11,5	25	4017166273854	
273861	schwarz/black	6 Tassen	11,5	25	4017166273861	



220–240 V | 50 Hz | 480 W

ESPRESSOKOCHER LISBOA

ELEKTRISCH

Edelstahl poliert, kabelloser Zentralkontakt 360°, Warmhaltefunktion, Ein-/Ausschalter mit Kontrollleuchte

ESPRESSO MAKER CLASSICO, electric. Stainless steel mirror polished, cordless, 360° degree base, keeping warm function, on/off switch with control lamp, 6 cups

Art.-Nr.	Inhalt	Ø	Höhe cm	EAN	
273755	4 Tassen	11,5	24	4017166273755	
273809	6 Tassen	11,5	25	4017166273809	



220–240 V | 50 Hz | 480 W

Geschichte

Der Name Mokka ist von der jemenitischen Hafenstadt al-Much-a abgeleitet. Von dort wurde Kaffee in die ganze Welt verschifft.

Die typische Zubereitungsart des Mokka ist seit dem 16. Jahrhundert bekannt. Dafür werden hochfeines Kaffeepulver und Zucker in eine spezielle Kanne (Ibrik) gegeben und mit Wasser aufgegossen. Der Zucker löst sich beim Erhitzen unter ständigem Umrühren auf. Beim ersten Aufkochen bildet sich Schaum an der Oberfläche, der in die Tassen gegeben wird, bevor man die Mischung ein zweites Mal aufkocht.

Das fertige Getränk enthält feine Schwebeteilchen und hat eine dickflüssige Konsistenz. Traditionell wird der Mokka mit Kardamon, Zimt, Nelken oder Rosenwasser gewürzt.

History

The name mocha is derived from the Yemen port city al-Much-a. Coffee was shipped from there to the entire world.

The typical type of preparing mocha has been known since the 16th century. Very finely ground coffee and sugar are added to a special pitcher (ibrik) and infused with water. The sugar is dissolved while being heated up and stirred constantly. When it is brought to a boil, foam forms in the surface and is then added to the cups before the mixture is boiled a second time.

The finished beverage contains fine suspended particles and has a viscous consistency. Traditionally, mocha is seasoned with cardamom, cinnamon, cloves or rose water.



TÜRKISCH MOKKA-KOCHER ORIENTE

ELEKTRISCH

Edelstahl satiniert, kabelloser Zentralkontakt 360°, automatische Abschaltfunktion, Warmhaltefunktion, Ein-/Ausschalter mit Kontrollleuchte

TURKISH COFFEE MAKER ORIENTE, electric. Stainless steel satin finish, cordless, 360° degree base, keeping warm function, on/off switch with control lamp

Art.-Nr.	Inhalt	Ø	Höhe cm	EAN	
273915	200 ml	10,5	18	4017166273915	



220-240 V | 50 Hz | 800 W

Produkt in Geschenkverpackung | Product in giftbox = 





KAFFEEÜTENKLAMMERN

Edelstahl satiniert
BAG CLIPS. Stainless steel satin finish

Art.-Nr.	Inhalt	Länge cm	EAN	
201468	2 Stück im Set / set of 2 pieces	11,5	4017166201468	
201475	3 Stück im Set / set of 3 pieces	8	4017166201475	



ESPRESSOMÜHLE AROMA

Edelstahl satiniert, stufenlos verstellbares Mahlwerk aus Hochleistungskeramik, Auffangbehälter mit Sichtfenster

ESPRESSO MILL AROMA. Stainless steel satin finish, stepless adjustable grinder made of high-tech ceramics, collecting container with inspection window, for 40g coffee beans

Art.-Nr.		Ø	Höhe cm	EAN	
610000	für 40g Bohnen	5	21	4017166610000	

MINI KOCHPLATTE

ELEKTRISCH

Metall, Hammerschlag-Lackierung, mit Kontrollleuchte und Überhitzungsschutz, ideal für alle Espressokocher und Cappuccino Creamer, stufenlos regelbar, schnell und sicher - auch auf Reisen

MINI HOTPLATE, electric. Metal, lacquered, with control lamp and overheat protection, suitable for all espresso makers and milk frother, infinitely variable, fast and safe - even for traveling



Art.-Nr.		Ø	Größe cm		
492309	Herdplatte:	10,5	14 x 14 x 6,5	4017166492309	

220-240 V | 50/60 Hz | 500 W

ESPRESSO-AUSSCHLAGDOSE

Edelstahl poliert, abnehmbare silikonummantelte Ausschlagstange, rutschfester Boden

ESPRESSO KNOCK BOX. Stainless steel mirror polished, removable silicone covered bar, anti-slip bottom



Art.-Nr.		Ø	Höhe cm	EAN	
550689		14	15,5	4017166550689	

ESPRESSODRÜCKER

ESPRESSODRÜCKER LOMBARDIA. Edelstahl poliert
ESPRESSO TAMPER LOMBARDIA. Stainless steel

ESPRESSODRÜCKER VENETO. Edelstahl poliert / schwarz lackiert
ESPRESSO TAMPER VENETO. Stainless steel / lacquered in black

Art.-Nr.		Ø	Höhe cm	EAN	
152012	1 LOMBARDIA	5,3	8	4017166152012	
152005	2 VENETO	5,8	8,5	4017166152005	



ESPRESSODRÜCKER

Edelstahl poliert, zwei Stempel: Ø 4,7 cm und Ø 5,5 cm
ESPRESSO TAMPER. Stainless steel mirror polished, two tamping sides:
Ø 4,7 cm and 5,5 cm

Art.-Nr.		Ø	Höhe cm	EAN	
200522		4,7 / 5,5	6,5	4017166200522	



ESPRESSODRÜCKER MIT KAFFEELÖT

Edelstahl poliert
ESPRESSO TAMPER WITH COFFEE MEASURE. Stainless steel mirror polished

Art.-Nr.		Ø	Höhe cm	EAN	
200621	für 5g Kaffee	4,7	14	4017166200621	



KAFFEELÖT

Edelstahl satiniert
COFFEE MEASURE. Stainless steel satin finish

Art.-Nr.		Ø	Höhe cm	EAN	
201451	für 7g Kaffee	3,2	14,5	4017166201451	



Reinster Kaffeegenuss – kalt oder warm

Purest coffee enjoyment – cold or hot

Wie einige gute Erfindungen wurde auch der Kaffeebereiter zufällig entdeckt. Ein Franzose soll um 1800 vergessen haben, seinen Kaffee mit Wasser aufzukochen – was damals üblich war. Stattdessen goss er einfach das heiße Wasser über den Kaffee und filterte diesen mit einem Sieb.

Et voilà: Der Kaffeebereiter „French Press“ war geboren.

Kaffee aus der „French Press“ zeichnet sich durch ein ausgeprägtes Aroma aus. Deswegen gehört sie bei Kaffee-freunden seit vielen Jahrzehnten zu den beliebtesten Zubereitungsmethoden.

Like some other good inventions, the coffee maker was discovered by accident. Around 1800 a Frenchman is said to have forgotten to boil his coffee with water - which was common then. Instead, he just poured the hot water over the coffee and filtered the coffee with a strainer.

Et voilà: the coffee maker "French Press" was born.

Coffee from the "French Press" is characterized by an intense flavour. That is why it has been belonging to the most popular cooking methods among coffee lovers for many years.



KAFFEEBEREITER MARIELLA

Hochwertiger Kunststoff, mit hitzebeständigem Borosilikatglas, auch für die Zubereitung von Cold Brew oder Tee geeignet
FRENCH PRESS MARIELLA. High-quality plastics, heat resistant borosilicate glass, also perfect to prepare Cold Brew or tea

Art.-Nr.	Inhalt	Farbe	Ø	Höhe cm	EAN 
345926	3 Tassen/350 ml	schwarz/black	8	17,5	4017166345926
345933	6 Tassen/800 ml	schwarz/black	11	20,5	4017166345933
346015	8 Tassen/1 L	cool grey	11	22,5	4017166346015
346022	8 Tassen/1 L	taupe	11	22,5	4017166346022
346039	8 Tassen/1 L	ocean blue	11	22,5	4017166346039
346046	8 Tassen/1 L	berry	11	22,5	4017166346046
345940	8 Tassen/1 L	schwarz/black	11	22,5	4017166345940



KAFFEEBEREITER NADINE

Edelstahl poliert, mit hitzebeständigem Borosilikatglas, auch für die Zubereitung von Cold Brew oder Tee geeignet

FRENCH PRESS NADINE. Stainless steel mirror polished, with heat resistant borosilicate glass, also perfect to prepare Cold brew or tea

Art.-Nr.	Inhalt	Ø	Höhe cm	EAN	
345902	3 Tassen/350 ml	7,5	17,5	4017166345902	
345919	8 Tassen/1 L	10	22	4017166345919	



KAFFEEBEREITER GLORIA

Edelstahl poliert, mit hitzebeständigem Borosilikatglas, auch für die Zubereitung von Cold Brew oder Tee geeignet

FRENCH PRESS GLORIA. Stainless steel mirror polished, with heat resistant borosilicate glass, also perfect to prepare Cold brew or tea

Art.-Nr.	Inhalt	Ø	Höhe cm	EAN	
345001	3 Tassen/350 ml	8,5	17	4017166345001	
345018	8 Tassen/1 L	10	21	4017166345018	



KAFFEEBEREITER LAURA

Edelstahl poliert, mit hitzebeständigem Borosilikatglas, auch für die Zubereitung von Cold Brew oder Tee geeignet

FRENCH PRESS LAURA. Stainless steel mirror polished, with heat resistant borosilicate glass, also perfect to prepare Cold brew or tea

Art.-Nr.	Inhalt	Ø	Höhe cm	EAN	
342130	3 Tassen/350 ml	7	16	4017166342130	
342147	6 Tassen/800 ml	9,5	19,5	4017166342147	
342154	8 Tassen/1 L	9,5	21	4017166342154	



KAFFEEBEREITER SARA

Edelstahl poliert, doppelwandig, isolierend, auch für die Zubereitung von Cold Brew oder Tee geeignet

FRENCH PRESS SARA. Stainless steel mirror polished, double wall, isolating, also perfect to prepare Cold brew or tea

Art.-Nr.	Inhalt	Ø	Höhe cm	EAN	
540260	6 Tassen/700 ml	9	19	4017166540260	
540277	8 Tassen/1 L	10	21,5	4017166540277	



KAFFEEBEREITER PERFETTO

Perfekter Kaffeegenuss dank extra feinem Mikrofilter und Kugelventil

Hochwertiger Kunststoff, BPA-frei. Der extra feine Mikrofilter und der Filtereinsatz mit Dichtung halten den Kaffeesatz zuverlässig zurück, das Kugelventil verhindert das Nachziehen des Kaffees, um Bitterstoffe zu reduzieren.

Mit rutschfestem Boden, auch für die Zubereitung von Cold Brew oder Tee geeignet

Perfect coffee enjoyment thanks to extra fine micro filter and ball valve

FRENCH PRESS PERFETTO. High-quality plastics, BPA free. The extra fine filter and the filter insert with seal reliably retain coffee grounds, the ball valve prevents from over extraction of the coffee and the formation of bitter flavours.

With anti-slip bottom, also perfect to prepare Cold Brew or tea

Art.-Nr.	Inhalt	Ø	Höhe cm	EAN	
347005	4 Tassen/500 ml	9	17,5	4017166347005	



Milchaufschäumer

Kann der perfekte Milchschaum den Kaffeegenuss in ungeahnte Höhen treiben? Ja, denn je nachdem, wie dieser sich mit dem Kaffee vermischt, trifft das geliebte Getränk anders auf Zunge und Gaumen und bildet so das Geschmackserlebnis.

cilio bietet mit seinen Milchaufschäumern die idealen Lösungen, um den vollmundigen Kaffee mit einem zart cremigen und besonders feinporigen Milchschaum zu veredeln. Nahezu mühelos und schnell zaubern die praktischen Helfer einen Schaum von meisterhafter Konsistenz.

Milk frothers

Can the perfect milk foam bring coffee enjoyment to unimagined heights? Yes, because the beverage hits the tongue and the pallet differently depending on how it is mixed with the coffee, which affects the taste experience.

cilio offers the ideal solutions with its milk frothers to enhance the full-bodied coffee with a delicate, creamy and finely-pored milk foam. These useful aids conjure up foam with masterful consistency quickly and almost effortlessly.

CAPPUCCINO CREAMER CLASSIC

Edelstahl poliert, mit Sandwichboden, inkl. Skala, auch für Induktion geeignet*
MILK FROTHER CLASSIC. Stainless steel mirror polished, with sandwich bottom, incl. scale, also suitable for induction*

Art.-Nr.	Inhalt	Ø	Höhe cm	EAN	
550283	3 Tassen/350 ml	8	18,5	4017166550283	
550290	6 Tassen/800 ml	10	20,5	4017166550290	



CAPPUCCINO CREAMER DELUXE

Edelstahl poliert mit Glasdeckel und Sandwichboden, inkl. Skala, auch für Induktion geeignet*
MILK FROTHER DELUXE. Stainless steel mirror polished with sandwich bottom and glass lid, incl. scale, also suitable for induction*

Art.-Nr.	Inhalt	Ø	Höhe cm	EAN	
550269	3 Tassen/350 ml	8	16,5	4017166550269	
550276	6 Tassen/800 ml	10	18,5	4017166550276	



* Induktionsgeeignet abhängig vom Mindestdurchmesser der Topferkennung Ihres Herdes. | Suitable for induction depending on the minimum diameter of your pan detection.

Produkt in Geschenkverpackung | Product in giftbox = 



MILCHAUFSCHÄUMER *aerolatte* KUH-DESIGN

Inkl. Aufbewahrungsdose, inkl. 2 Alkaline-Batterien, Typ 1,5V(AA)

Art.-Nr.	Höhe cm	EAN
100365**	21	5039179000745

** bei Abnahme von 12 Stück Lieferung im farbigen Verkaufsdisplay



MILCHAUFSCHÄUMER *aerolatte* COLOUR EDITION

Inkl. 2 Alkaline-Batterien, Typ 1,5V(AA)

Art.-Nr.	Farbe	Höhe cm	EAN
100457**	schwarz	21	5039179001155
100464**	rot	21	5039179001131

** bei Abnahme von 6 Stück Lieferung im farbigen Verkaufsdisplay



MILCHAUFSCHÄUMER *aerolatte* CHROM EDITION

Inkl. 2 Alkaline-Batterien, Typ 1,5V(AA)

Art.-Nr.	Höhe cm	EAN
100204**	21	5039179000172

** bei Abnahme von 6 Stück Lieferung im farbigen Verkaufsdisplay



1 Kalte oder warme Milch in ein hohes Gefäß gießen. Bis maximal zu $\frac{1}{2}$ füllen.



2 Rührstab bis knapp über den Boden eintauchen.



3 Aufschäumer einschalten, langsam und kreisförmig von unten nach oben bewegen, bis die Milch die gewünschte Konsistenz hat.



4 Milchschaum auf Ihren Kaffee – Fertig!

MILCHAUFSCÄUMER *aerolatte* DELUXE EDITION

Edelstahl satiniert, inkl. 2 Alkaline-Batterien, Typ 1,5V(AA)

Art.-Nr.	Höhe cm	EAN	
100310**	22	5039179000486	

** bei Abnahme von 6 Stück Lieferung im farbigen Verkaufsdisplay



QUIRL *aerolatte* MATCHA

Kunststoff in Bambus-Optik, inkl. 2 Alkaline-Batterien, Typ 1,5V(AA)



Art.-Nr.	Höhe cm	EAN	
100594	21	5039179001056	

Matcha, hauchfein zermahlene Blätter vom grünen Tee, zählt zu den Superfood-Produkten weltweit. Matcha-Pulver ist nicht nur die Basis für ein gesundes Getränk, sondern ein echter Allrounder in Küche & Bar. Trendigen Smoothies, spritzigen Limonaden und Salatdressings gibt Matcha das besondere Etwas.



MILCHAUFSCÄUMER CREMA

ELEKTRISCH

Edelstahl poliert, elektrisch, kabelloser 360° Zentralkontakt, An- / Ausschalter mit Kontrollleuchten für warmes oder kaltes Aufschäumen bzw. Verrühren, Antihafbeschichtung, innenliegende Skala, Abschaltautomatik, inkl. Spirale für Milchschaum, inkl. Quirl für Milchmixgetränke, integrierter Sensor für optimale Temperatur von 60 – 70 °C

MILK FROTHER CREMA, electric. Stainless steel mirror polished, cordless central contact 360°, On / off button with control lights for warm or cold foaming or mixing, non-stick coating, scale inside, automatic switch-off function, incl. spiral for milk-foam, incl. whisk for milk drinks, integrated sensor for perfekt temperature 60 – 70 °C

Art.-Nr.	Inhalt	Ø	Höhe cm	EAN	
103007	250 ml	10	18,5	4017166103007	
103014	500 ml	11,5	21,5	4017166103014	

220–240 V | 50 / 60 Hz | 500 W oder 650 W



Produkt in Geschenkverpackung | Product in giftbox = 

MILCHKANNE ELISA

Edelstahl poliert, mit Thermometerstreifen von 37°C bis 70°C, auch für Induktion geeignet* (nur bis max. mittlere Stufe)

MILK JUG ELISA. stainless steel, with thermometer stripe from 37°C to 70°C, also suitable for induction* (up to medium level at the maximum)



Art.-Nr.	Inhalt	Ø	Höhe cm	EAN	
470260	600 ml	8,5 cm	11 cm	4017166470260	
470277	1000 ml	10 cm	13,5 cm	4017166470277	

AUFSCÄUMBECHER PROFESSIONAL

Edelstahl poliert, mit Sandwichboden, auch für Induktion geeignet*

FOAM CUP PROFESSIONAL. Stainless steel mirror polished. With sandwich bottom. Also suitable for induction*



Art.-Nr.	Inhalt	Ø	Höhe cm	EAN
299601	350 ml	6,5	9	4017166299601
299618	750 ml	8	11	4017166299618

AUFSCÄUMBECHER CLASSIC

Edelstahl poliert

FOAM CUP CLASSIC. Stainless steel mirror polished



Art.-Nr.	Inhalt	Ø	Höhe cm	EAN
293173	250 ml	6	9	4017166293173
293166	500 ml	7,5	11	4017166293166

MILCHKANNE LISA

Edelstahl poliert

MILK JUG LISA. Stainless steel mirror polished



Art.-Nr.	Inhalt	Ø	Höhe cm	EAN
470192	300 ml	7	8	4017166470192
470208	600 ml	8	10,5	4017166470208
470215	900 ml	10	12	4017166470215

* Induktionsgeeignet abhängig vom Mindestdurchmesser der Topferkennung Ihres Herdes. | Suitable for induction depending on the minimum diameter of your pan detection.

Produkt in Geschenkverpackung | Product in giftbox = 

MILCHTHERMOMETER

Edelstahl poliert, Markierung für optimale Aufschäumtemperatur (60°-70°C), verstellbarer Clip für unterschiedliche Gefäßhöhen, Skala bis 100°C / 220°F

MILK THERMOMETER. Stainless steel mirror polished. Marking for perfect temperature (60°-70°C), movable clip for different frother sizes, dial up to 100°C / 220°F

Art.-Nr.	Ø	Höhe cm	EAN	
280104	4,5	14	4017166280104	



LATTE MACCHIATO-KÄNNCHEN

Edelstahl poliert, zum leichten Einfüllen des Espressos für einen authentischen Latte Macchiato

LATTE MACCHIATO JUG. Stainless steel mirror polished, best for preparing an authentic Latte Macchiato

Art.-Nr.	Inhalt	Ø	Höhe cm	EAN	
201383	100 ml	5,5	5,5	4017166201383	



DEKORIERSCHABLONEN aerolatte[®] CAPPUCCINO ART™

Hochwertiger Kunststoff, 6 Schablonen im Set (Blatt / Gesicht / Stern / Herz / Schneeflocke / Wirbel), in praktischer Aufbewahrungsdose

Art.-Nr.	Größe cm	EAN	
100372**	11 x 9	5039179000882	

**Bei Abnahme von 12 Sets Lieferung im farbigen Verkaufsdisplay



DEKORIERSTREUER aerolatte[®] ARTIST

Hochwertiger Kunststoff, mit 6 Schablonen (Blatt / Gesicht / Stern / Herz / Schneeflocke / Wirbel), mit praktischem Aufbewahrungsfach

Art.-Nr.	Ø	Höhe cm	EAN	
100761	6	12	4017166100761	



DEKORIERSTREUER

Edelstahl poliert, mit 3 Schablonen (Gesicht / Herz / Stern)

DECORATING DREDGER. Stainless steel mirror polished, with 3 stencils (face / heart / star)

Art.-Nr.	Ø	Höhe cm	EAN	
201307	6,5	13	4017166201307	



Kaffee-Filterstation DRIP-MASTER

Filterkaffee wie von Hand aufgebrüht –
ab jetzt ganz einfach mit dem DRIP-MASTER von **cilio**.

Geben Sie nur Kaffeepulver in den Filter und heißes Wasser in den Tank. Der Rest geht von allein. Der Wassertank rotiert und übergießt das Kaffeepulver langsam und gleichmäßig mit heißem Wasser – für bis zu zwei Tassen perfekt aufgebrühten Kaffee mit vollem Aroma. Erhältlich mit einzel- und doppelwandiger Glaskanne.

Kleine Bohnenkunde

Weltweit existieren ca. 100 Kaffeesorten. Hauptverantwortlich für ihre Eigenschaften sind Anbau und Aufbereitung der Bohne. Am beliebtesten sind die eher milde „Arabica“ mit 1,1 bis 1,7 Prozent Koffein, sowie die leicht holzige „Robusta“, die in ihrer Reifezeit die zwei- bis dreifache Menge an Koffein entwickelt.

Coffee filter station DRIP-MASTER

Filter coffee as if brewed by hand – really simple with the **cilio** DRIP-MASTER.

Just fill coffee powder in the filter and hot water in the tank. The rest is done by itself. The water tank rotates and sprinkles the coffee powder slowly and evenly with hot water - for up to two cups of perfectly brewed coffee with full flavour. Available with single or double-walled glass jug.

Small bean course

There are about 100 types of coffee worldwide. Cultivation and preparation are primarily responsible for their characteristics. The most beloved are the rather mild „Arabica“ with 1.1 to 1.7 per cent caffeine, as well as the slightly woody „Robusta“, which develops two to three times the amount of caffeine during its maturing time.



KAFFEE-FILTERSTATION DRIP-MASTER

- Einwandige Glaskanne
- 2 Alkaline-Batterien Typ 1,5V (AA) (Nicht im Lieferumfang enthalten)

COFFEE FILTER STATION DRIP-MASTER

- Single wall glass jug
- 2 alkaline batteries type 1,5V (AA) (not included)

Art.-Nr.	Inhalt	Ø	Höhe cm	EAN	
343007	2 Tassen/350 ml	16,5	30	4017166343007	



KAFFEE-FILTERSTATION DRIP-MASTER

DOPPELWAND

- Doppelwandige Glaskanne
- 3 Alkaline-Batterien Typ 1,5V (AA) (Nicht im Lieferumfang enthalten)

COFFEE FILTER STATION DRIP-MASTER

- Double wall glass jug
- 3 alkaline batteries type 1,5V (AA) (not included)

Art.-Nr.	Inhalt	Ø	Höhe cm	EAN	
343014	2 Tassen/350 ml	16,5	30	4017166343014	



Wassertank und Filter aus TRITAN, BPA-frei, Kanne aus hitzebeständigem Glas, inkl. Kaffeemaß, batteriebetrieben, batterieschonende Abschaltautomatik, rotierendes Brühsystem / 3 Drehungen pro Minute, Ein- und Ausschalter mit Kontrollleuchte, passend für Papierfilter Größe 101/1

Water tank and filter made of TRITAN, BPA free, jug made of heat-resistant glass, incl. coffee measure, battery operated, battery-saving automatic switch-off, rotating brewing system / 3 rotations per minute, on/off switch with indicator light, suitable for paper filter bags size 101/1

cilio

KAFFEEWELT



KAFFEEFILTER

Keramik, weiß glasiert, bei ca. 1.300°C gebrannt

COFFEE FILTER. Ceramics, white glazed, burnt at approx. 1.300°C

Art.-Nr.	Größe	Ø	Höhe cm	EAN	
105544	1	9,5	7	4017166105544	
105162	2	12	10	4017166105162	
104943	4	14	10,5	4017166104943	
105179	6	16	13,5	4017166105179	



HANDBRÜH-WASSERKOCHER LUCCA

ELEKTRISCH

Edelstahl satiniert, 6 voreingestellte Temperaturen (70°C / 75°C / 85°C / 90°C / 95°C / 100°C), kabelloser 360° Zentralkontakt, Warmhaltefunktion bis zu 30 Minuten, automatische Abschaltfunktion, Ein-/Ausschalter mit Kontrollleuchte, ideal für den präzisen Handaufguss von Kaffee oder Tee dank des Schwanenhalses

POUR-OVER WATER KETTLE LUCCA, electric. Stainless steel satin finish, 6 pre-set temperatures (70°C / 75°C / 85°C / 90°C / 95°C / 100°C), cordless central contact 360°, warming function up to 30 minutes, automatic switch-off function, on/off switch with control light, perfect for the manual brewing of coffee or tea thanks to the gooseneck spout

Art.-Nr.	Inhalt	Ø	Höhe cm	EAN	
491692	1,2 L / 800 ml	16	19	4017166491692	



220-240 V | 50 Hz | 1000 W



Produkt in Geschenkverpackung | Product in giftbox = 

Gar nicht Oldschool: klassischer Filterkaffee

By no means old school: classic filtered coffee

Die vielen Fans der Handfiltermethode haben gute Argumente: Der Kaffee enthält z.B. weniger Bitterstoffe, wodurch die Aromenvielfalt und feinste Geschmacksnuancen viel besser erlebbar sind.

The many fans of the hand filtering method have good arguments: The coffee contains e.g. fewer bitters, which makes the variety of aromas and finest flavour nuances much easier to enjoy.

Wer diesen vollendeten Kaffeegenuss sucht, findet dafür im **cilio** Sortiment Kaffeefilter und Dauerfilter in unterschiedlichen Größen und Ausführungen. Eine Eigenschaft ist allen gemeinsam: Sie filtern das Beste aus jedem Kaffeepulver!

If you are looking for this perfect coffee enjoyment, you will find coffee filters and permanent filters in a wide range of sizes and designs in the **cilio** assortment. They all have one characteristic in common: They filter the best out of every coffee!



KAFFEEFILTER

Keramik, außen farbig, innen weiß glasiert, bei ca. 1.300°C gebrannt

COFFEE FILTER. Ceramics, outside colored, inside white glazed, burnt at approx. 1.300°C

Art.-Nr.	Farbe	Größe	Ø	Höhe cm	EAN
106138	pastell grün/pastel green	4	14	10,5	4017166106138
106145	pastell blau/pastel blue	4	14	10,5	4017166106145
106152	silber/silver	4	14	10,5	4017166106152
106169	gold	4	14	10,5	4017166106169
106121	amarena	4	14	10,5	4017166106121



Produkt in Geschenkverpackung | Product in giftbox = 

KAFFEEMÜHLE ROBUSTA

ELEKTRISCH

Hochwertiger Kunststoff, Scheibenmahlwerk aus gehärtetem Stahl, präzise Mahlwerkeinstellung mit 17 Stufen von sehr fein bis sehr grob, stufenlose Mengenvorwahl für 1-12 Tassen Kaffee, Abschaltautomatik, inkl. Reinigungspinsel

COFFEE MILL ROBUSTA. High-quality plastics, electric, with burr grinding system made of hardened steel, precise grinding adjustment with 17 steps from extra fine to very coarse, stepless quantity selection for 1-12 cups of coffee, automatic switch-off function, incl. cleaning brush

Art.-Nr.	Größe cm	EAN	
491104	15,5 x 10,5 x 22,5	4017166491104	

220-240 V | 50/60 Hz | 100 W



KAFFEEFILTER

Acryl, inkl. Kaffeelot, mit Auflage, passend für Papierfilter Größe 4

COFFEE FILTER. Acrylic, incl. coffee measure, with base, suitable for filter paper size 4

Art.-Nr.	Größe	Ø	Höhe cm	EAN	
345049	4	13,5	10,5	4017166345049	



Produkt in Geschenkverpackung | Product in giftbox = 



DAUERFILTER FÜR KAFFEE GOLD

Spezial gehärtet und 24 Karat vergoldet, wiederverwendbarer Dauerfilter, absolut geschmacksneutral, passend für Kaffeefilter Größe 2 oder 4

PERMANENT FILTER FOR COFFEE GOLD. Especially hardened and 24 carat gold plated, reusable permanent coffee filters, absolutely tasteless, suitable for coffee filter size 2 or 4

Art.-Nr.	Größe	Ø	Höhe cm	EAN	
116014	2	10,5	8	4017166116014	
116007	4	12,5	9	4017166116007	



DAUERFILTER FÜR KAFFEE EDELSTAHL

Spezial gehärtet, Edelstahl rostfrei, wiederverwendbarer Dauerfilter, absolut geschmacksneutral, passend für Kaffeefilter Größe 2 oder 4

PERMANENT FILTER FOR COFFEE STAINLESS STEEL. Especially hardened stainless steel, permanent coffee filter, absolutely tasteless, suitable for coffee filters size 2 or 4

Art.-Nr.	Größe	Ø	Höhe cm	EAN	
116021	4	12,5	9	4017166116021	



KAFFEEFILTER MIT STUTZEN

Keramik, weiß glasiert, bei ca. 1.300°C gebrannt, für direkten Handaufguss in Isolierkannen, -flaschen und -becher, mit breiter Auflage für sicheren Stand

COFFEE FILTER WITH EXTENSION. Ceramic, white, burnt at approx. 1.300°C, for direct hand infusion in insulating jugs, bottles and mugs, with wide base for secure standing position

Art.-Nr.	Größe	Ø	Höhe cm	EAN	
106091	4	13,5	14	4017166106091	

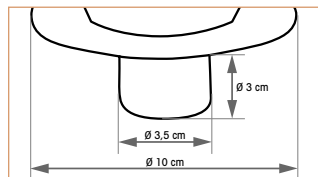

KAFFEEFILTER VIENNA

Feuerfestes Hartporzellan, weiß, bei ca. 1.300°C gebrannt, mit spiralförmigem Lamellenverlauf, passend für Papierfilter Größe 4

COFFEE FILTER VIENNA. Fireproof hard porcelain, white, burnt at approx. 1.300°C, with spiraled ridges, suitable for filter paper size 4

Art.-Nr.	Größe	Ø	Höhe cm	EAN	
106077	4	13,5	10,5	4017166106077	

Design:
AKANTUS®

KAFFEEKANNE MIT FILTER VIENNA

Feuerfestes Hartporzellan, weiß, bei ca. 1.300°C gebrannt, Kaffeefilter Größe 4, tropffreier Ausguss, Filter mit breiter Auflage für sicheren Stand, glasierter Boden, mit spiralförmigem Lamellenverlauf, passend für Papierfilter Größe 4

COFFEE POT WITH FILTER VIENNA. Fireproof hard porcelain, white, burnt at approx. 1.300°C, coffee filter size 4 with spiraled ridges, drip free pourer, filter with wide base for secure standing position, suitable for filter paper size 4

Art.-Nr.	Inhalt/Größe	Ø	Höhe cm	EAN	
106060				4017166106060	

Kanne:	1 L	14	18
Kaffeefilter:	Größe 4	13,5	10,5

Design:
AKANTUS®



KANNE

Feuerfestes Hartporzellan, weiß, bei ca. 1.300°C gebrannt

POT. Fire-proof hard porcelain, white, burnt at approx. 1.300°C

Art.-Nr.	Inhalt	Größe cm	EAN
104158	1,25 L	9 x 15 x 13,5	4017166104158
105155	1,75 L	10 x 17,5 x 15,5	4017166105155



STÖVCHEN

Feuerfestes Hartporzellan, weiß, bei ca. 1.300°C gebrannt, inkl. Teelicht

WARMER. Fire-proof hard porcelain, white, burnt at approx. 1.300°C incl. tea light

Art.-Nr.	Ø	Höhe cm	EAN
104141	16	6	4017166104141



KANNE MIT RECHAUD

Feuerfestes Hartporzellan, weiß, bei ca. 1.300°C gebrannt, inkl. Teelicht

POT WITH WARMER. Fire-proof hard porcelain, white, burnt at approx. 1.300°C, incl. tealight

Art.-Nr.	Inhalt	Größe cm	EAN	
105148	1,1 L	16 x 23,5 x 18	4017166105148	





WASSERKOCHER VESUVIO

ELEKTRISCH

Glas-Gehäuse, kabelloser 360° Zentralkontakt, automatische Abschaltfunktion, Ein- / Ausschalter mit Kontrollleuchte, Skala zum Abmessen des Wasserstandes, herausnehmbarer Kalkfilter, Sicherheitsverschluss

WATER KETTLE VESUVIO, electric. Glass-housing, cordless central contact 360°, automatic switch-off function, on/off switch with control light, scale for measuring the water level, removable limescale filter, safety lock

Art.-Nr.	Inhalt	Ø	Höhe cm	EAN	
492521	2 L	15	26	4017166492521	

220-240 V | 50/60 Hz | 1850-2200 W



KALKFÄNGER KALKFEE

Edelstahl rostfrei, verringert Kalkablagerungen in Wasserkesseln und elektrischen Wasserkochern, feine Maschen binden den Kalk und sorgen so für bessere Wasserqualität. 10 Stück im farbigen Verkaufsdisplay

LIMESCALE CATCHER KALKFEE. Stainless steel, reduces lime deposits in water kettles and electric water kettles, fine mesh catches the lime and improves the water quality

Art.-Nr.	Ø	EAN	
102024**	4,5	4017166102024	

**Bei Abnahme von 10 Stück Lieferung im farbigen Verkaufsdisplay
When ordering 10 pieces delivery in colored display package

WASSERKESSEL COUNT

Edelstahl lackiert, induktionsgeeigneter Kapselboden, wärmeisolierender Griff, harmonische Flöte, geeignet für alle Herdarten - insbesondere für Induktion und Glaskeramik, Inhalt: 2,5 L, maximale Füllmenge zum Wasserkochen: 1,8 L

WATER KETTLE COUNT. Stainless steel mirror polished, capsuled bottom, heat insulating handle, harmonious whistle, suitable for all kinds of stove incl. induction, capacity: 2,5 L, max. capacity to boil water: 1,8 L

Art.-Nr.	Farbe	Ø	Höhe cm	EAN	
430509	schwarz/black	19,5	24,5	4017166430509	
430516	weiß/white	19,5	24,5	4017166430516	
430530	rot/red	19,5	24,5	4017166430530	

Bodendurchmesser 14 cm



WASSERKESSEL EARL

Edelstahl poliert, induktionsgeeigneter Kapselboden, wärmeisolierender Griff, harmonische Flöte, geeignet für alle Herdarten - insbesondere für Induktion und Glaskeramik, Inhalt: 2,5 L, maximale Füllmenge zum Wasserkochen: 1,5 L

WATER KETTLE EARL. Stainless steel mirror polished, capsuled bottom, heat insulating handle, harmonious whistle, suitable for all kinds of stove incl. induction, capacity: 2,5 L, max. capacity to boil water: 1,5 L

Art.-Nr.	Ø	Höhe cm	EAN	
430318	21	23	4017166430318	



WASSERKESSEL CLASSICO

Edelstahl poliert, induktionsgeeigneter Kapselboden, wärmeisolierender Griff, harmonische 2-Ton Flöte im Deckel, geeignet für alle Herdarten - insbesondere für Induktion und Glaskeramik, Inhalt: 2,5 L, maximale Füllmenge zum Wasserkochen: 1,8 L

WATER KETTLE CLASSICO. Stainless steel mirror polished, capsuled bottom, heat insulating handle, harmonious 2 sound whistle integrated in the lid, suitable for all kinds of stove incl. induction, capacity: 2,5 L, max. capacity to boil water: 1,8 L

Art.-Nr.	Ø	Höhe cm	EAN	
430806	17	24,5	4017166430806	



WASSERKESSEL TRADITION

Edelstahl poliert, Griff und Deckelknopf aus Holz (Robinie) induktionsgeeigneter Kapselboden, geeignet für alle Herdarten - insbesondere für Induktion und Glaskeramik, Inhalt: 2,5 L, maximale Füllmenge zum Wasserkochen: 1,7 L

WATER KETTLE TRADITION. Stainless steel mirror polished, handle and lid knob made of wood (Robinia), capsuled bottom, suitable for all kinds of stove incl. induction, capacity: 2,5 L, max. capacity to boil water: 1,7 L

Art.-Nr.	Ø	Höhe cm	EAN	
430820	18	25,5	4017166430820	



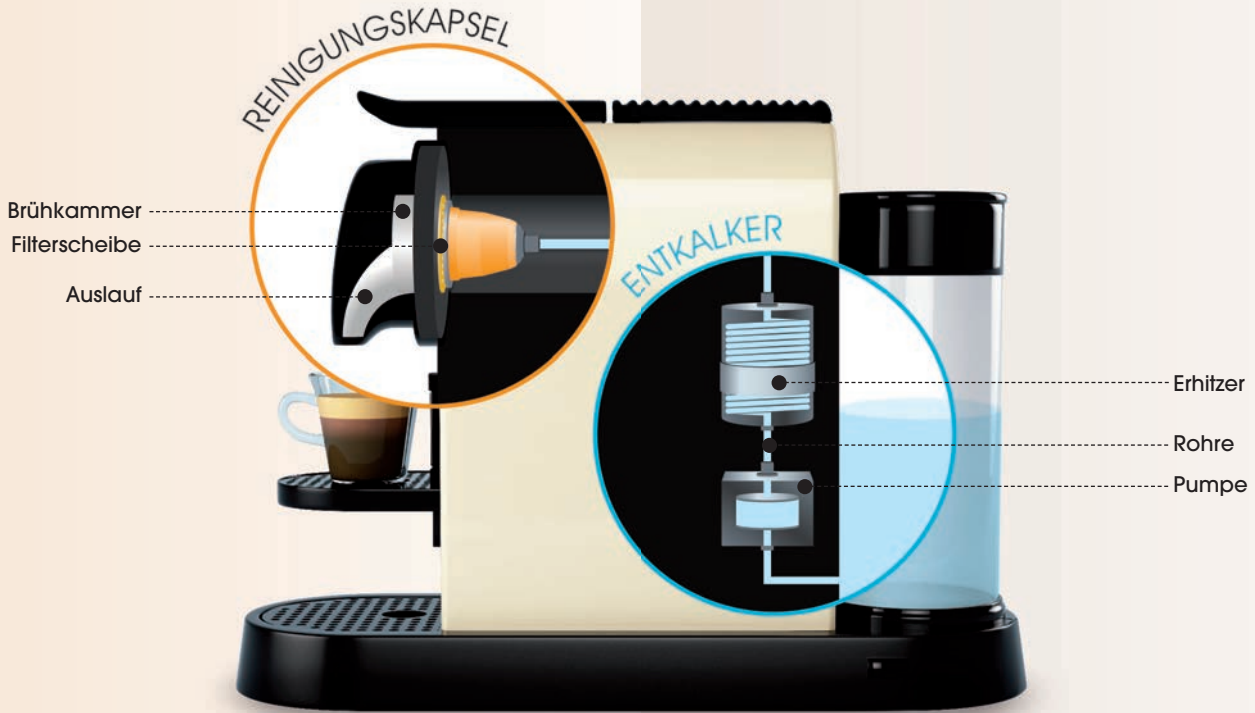

REINIGEN UND ENTKALKEN

Sind zwei verschiedene Prozesse

Reinigung

- Brühkammer
- Auslauf
- Rohre
- Pumpe
- Erhitzer

Verwendung

Nach etwa 30 Tassen Kaffee, also alle 1 - 4 Wochen, je nach Maschinennutzung

Alle 3 - 6 Monate, je nach Härtegrad des Wassers

Entfernt Ablagerungen

- Kaffee und andere Ablagerungen
- Schmutzpartikel und Gerüche
- Kalkablagerungen

Probleme

- Blockaden, die zu Maschinenausfall führen können
- Verunreinigter Kaffee und schmutzige Brühkammer
- Getrüübter Kaffeegeschmack
- Blockaden, die zu Maschinenausfall führen können
- Verringerte Effizienz des Erhitzers
- Kalter Kaffee

Wirkstoffe

Schäumende Reinigungslösung

Säurehaltige Reinigungslösung



Caffenu® Reinigungskapseln

Die erste Kapsel, die Ihre Nespresso®-Maschine schnell und einfach reinigt, verbessertes Kaffeearoma, verlängerte Lebensdauer der Maschine, 100% sicher, hergestellt aus biologisch abbaubaren und organischen Stoffen (SABS zertifiziert), Set à 5 Stück

Art.-Nr.	Inhalt	EAN	
102017	5 Stück	6001651066562	



Caffenu® Multipod-Reinigungskapseln

Für verbessertes Kaffeearoma und eine verlängerte Lebensdauer der Kaffeemaschine, speziell entwickelt für die beliebtesten Maschinen: Caffitaly® - K-fee® - Verismo® by Starbucks - Expressi® by Aldi - Tchibo® Cafissimo®, Set à 4 Stück

Art.-Nr.	Inhalt	EAN	
102031	4 Stück	6001651739701	



Caffenu® Eco-Flüssig Entkalker

Speziell entwickelt für Kapsel- und Kaffeepad-Maschinen, entfernt Kalkablagerungen in Rohren, Pumpe und Erhitzer, für verbessertes Kaffeearoma und verlängerte Lebensdauer der Kaffeemaschine

Art.-Nr.	Inhalt	EAN	
102048	200 ml	6001651058932	





ESPRESSOTASSE MILANO

Porzellan, extra dickwandig, mit Untertasse, Inhalt 50 ml
ESPRESSO CUP MILANO. Porcelain, extra thick wall, with saucer



Art.-Nr.	Farbe	Inhalt	EAN
215083	weiß/white	50 ml	4017166215083
215090	marone/chestnut	50 ml	4017166215090

TASSE ROMA WEISS

Porzellan, extra dickwandig, mit Untertasse
CUP ROMA, white. Porcelain, extra thick wall, with saucer



Art.-Nr.	Inhalt	EAN
215007	Espresso 50 ml	4017166215007
215014	Cappuccino 100 ml	4017166215014
215021	Milchkaffee/milk coffee 200 ml	4017166215021

TASSE ROMA MARONE

Porzellan, extra dickwandig, mit Untertasse
CUP ROMA, chestnut. Porcelain, extra thick wall, with saucer



Art.-Nr.	Inhalt	EAN
215045	Espresso 50 ml	4017166215045
215052	Cappuccino 100 ml	4017166215052
215069	Milchkaffee/milk coffee 200 ml	4017166215069

cilio



KAFFEEWELT

ESPRESSOTASSE ROMA

Porzellan, extra dickwandig, mit Untertasse
ESPRESSO CUP ROMA. Porcelain, extra thick wall, with saucer

Art.-Nr.	Farbe	Inhalt	EAN
215113	macchiato 1	50 ml	4017166215113
215120	amarena 2	50 ml	4017166215120
215229	cool grey 3	50 ml	4017166215229
215236	taupe 4	50 ml	4017166215236
215243	ocean blue 5	50 ml	4017166215243
215250	berry 6	50 ml	4017166215250



CAPPUCCINOTASSE ROMA

Porzellan, extra dickwandig, mit Untertasse
CAPPUCCINO CUP ROMA. Porcelain, extra thick wall, with saucer

Art.-Nr.	Farbe	Inhalt	EAN
215175	macchiato 1	100 ml	4017166215175
215182	amarena 2	100 ml	4017166215182
215274	cool grey 3	100 ml	4017166215274
215281	taupe 4	100 ml	4017166215281
215298	ocean blue 5	100 ml	4017166215298
215304	berry 6	100 ml	4017166215304



Produkt in Geschenkverpackung | Product in giftbox =

ESPRESSOBECHER

Porzellan, weiß, bei ca. 1.300°C gebrannt
ESPRESSO MUG. Porcelain, white, burnt at approx. 1.300°C



Art.-Nr.	Inhalt	Ø	Höhe cm	EAN
104035**	50 ml	6,5	5,5	4017166104035

**Bei Abnahme von 24 Stück Lieferung im farbigen Verkaufsdisplay
When ordering 24 pieces delivery in colored display package

ESPRESSOLÖFFEL GOCCIA

Edelstahl poliert, 6 Stück im Set
ESPRESSO SPOON GOCCIA, set of 6 pieces. Stainless steel mirror polished



Art.-Nr.	Länge cm	EAN	
125184	11	4017166125184	

ESPRESSO- UND CAPPUCCINOLÖFFEL ROMA

Edelstahl poliert
ESPRESSO AND CAPPUCCINO SPOON ROMA. Stainless steel mirror polished



Art.-Nr.		Länge cm	EAN
125009	Espresso	10,5	4017166125009
125016	Cappuccino	12,5	4017166125016

LATTE MACCHIATO-LÖFFEL ROMA

Edelstahl poliert
LATTE MACCHIATO SPOON ROMA. Stainless steel mirror polished



Art.-Nr.	Länge cm	EAN
125023	20	4017166125023



ESPRESSO-GLAS

Hitzebeständiges Borosilikatglas, doppelwandig, ideal für heiße und kalte Getränke, 2 Stück im Set

ESPRESSO GLASS. Heat resistant borosilicate glass, double wall, perfect for hot or cold beverages, set of 2 pieces

Art.-Nr.	Inhalt	Höhe cm	EAN	
292602	80 ml	6	4017166292602	



KAFFEE-GLAS

Hitzebeständiges Borosilikatglas, doppelwandig, ideal für heiße und kalte Getränke, 2 Stück im Set

COFFEE GLASS. Heat resistant borosilicate glass, double wall, perfect for hot or cold beverages, set of 2 pieces

Art.-Nr.	Inhalt	Höhe cm	EAN	
292619	250 ml	9	4017166292619	



MILCHKAFFEE-GLAS

Hitzebeständiges Borosilikatglas, doppelwandig, ideal für heiße und kalte Getränke, 2 Stück im Set

MILK COFFEE GLASS. Heat resistant borosilicate glass, double wall, perfect for hot or cold beverages, set of 2 pieces

Art.-Nr.	Inhalt	Höhe cm	EAN	
292626	350 ml	12	4017166292626	



LATTE MACCHIATO-GLAS

Hitzebeständiges Borosilikatglas, doppelwandig, ideal für heiße und kalte Getränke, 2 Stück im Set

LATTE MACCHIATO GLASS. Heat resistant borosilicate glass, double wall, perfect for hot or cold beverages, set of 2 pieces

Art.-Nr.	Inhalt	Höhe cm	EAN	
292633	450 ml	15	4017166292633	



ZUCKERDOSE UND MILCHKÄNNCHEN AIDA

Edelstahl poliert, Inhalt: 300 ml

SUGAR CANISTER AND MILK JUG AIDA. Stainless steel mirror polished, capacity: 300 ml



Art.-Nr.		Ø	Höhe cm	EAN	
342192	Zuckerdose	7,5	9,5	4017166342192	
342208	Milchkännchen	7,5	9,5	4017166342208	

ZUCKERDOSE UND MILCHKÄNNCHEN IM SET

Edelstahl poliert, inkl. Löffel und Tablett

SUGAR AND MILK SET. Stainless steel mirror polished, incl. spoon and tray



Art.-Nr.		Größe cm	EAN	
203004		19 x 11 x 9	4017166203004	

MILCH- UND ZUCKERSPENDER

Edelstahl satiniert, für bis zu 9 Milchdöschen und Zuckerstangen

MILK AND SUGAR DISPENSER. Stainless steel satin finish, for up to 9 coffee creamer pods and sugar sticks



Art.-Nr.		Größe cm	EAN	
202458		12,5 x 8,5 x 17,5	4017166202458	

MILCHKUH

Feuerfestes Hartporzellan, weiß, bei ca. 1.300°C gebrannt

COW MILK JUG. Fire-proof hard porcelain, white, burnt at approx. 1.300°C



Art.-Nr.	Inhalt	Größe cm	EAN
105186	100 ml	18,5 x 6 x 12	4017166105186

SERVIERTABLETT BISTRO

Edelstahl poliert

SERVING TRAY. Stainless steel mirror polished

Art.-Nr.	Größe cm	EAN	
200737	27 x 21	4017166200737	



SERVIERTABLETT BISTRO

Edelstahl poliert

SERVING TRAY BISTRO. Stainless steel mirror polished

Art.-Nr.	Größe cm	EAN	
201840	24 x 17	4017166201840	
201857	31 x 23	4017166201857	



STREUER MIDI

Edelstahl satiniert

SHAKER MIDI. Stainless steel satin finish

Art.-Nr.		Ø	Höhe cm	EAN	
300437	Netzstreuer	3,5	10	4017166300437	
300666	Kakaostreuer	3,5	10	4017166300666	
300680	Zuckerspender	3,5	10	4017166300680	



SÜSSSTOFFSPENDER

Edelstahl satiniert

SWEETENER DISPENSER. Stainless steel satin finish

Art.-Nr.	Ø	Höhe cm	EAN	
296099	3,5	10,5	4017166296099	



Wenn es mal wieder länger dauert....

If it takes longer again...

Kaffee und Tee schmecken am besten, wenn sie richtig heiß sind.

Coffee and tea taste best when they are really hot.

Aber auch kalte Getränke erfrischen erst richtig, wenn sie eiskalt sind. Damit das auf der Kaffeetafel oder im Meeting auch so bleibt, halten die Isolierkannen von **cilio** Getränke über Stunden auf Temperatur.

And cold drinks are just really refreshing when they are freezing cold. To keep things that way on the coffee table or in the meeting, the cilio insulated jugs keep the temperature for hours.

Doch auch unterwegs müssen wohl temperierte Getränke keine Wunschvorstellung bleiben - die **cilio** Isolierflaschen sind dafür der perfekte Begleiter.

But even on the go, well tempered drinks do not have to be a wishful thinking - the cilio insulated bottles are the perfect companion.

ISOLIEREN



ISOLIERKANNE VENEZIA

1L

Edelstahl poliert oder lackiert, Vakuum-Hartglaseinsatz, Schraubverschluss mit praktischer Einhand-Ausgießtaste, Inhalt: 1 L

INSULATED JUG VENEZIA. Stainless steel satin finish or lacquered, screw lid with useful one hand pouring button, capacity: 1 L

Art.-Nr.	Farbe	Ø	Höhe cm	EAN	
543926	poliert/mirror polished	14	27	4017166543926	
543933	weiß/white	14	27	4017166543933	
543940	rot/red	14	27	4017166543940	

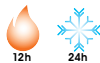

ISOLIERKANNE MILANO

1L

Edelstahl satiniert oder lackiert, Vakuum-Hartglaseinsatz, Schraubverschluss mit praktischer Einhand-Ausgießtaste, Inhalt: 1 L

INSULATED JUG MILANO. Stainless steel satin finish or lacquered, screw lid with useful one hand pouring button, capacity: 1 L

Art.-Nr.	Farbe	Ø	Höhe cm	EAN	
543957	satiniert/satin	16,5	23	4017166543957	
543964	weiß/white	16,5	23	4017166543964	
543971	rot/red	16,5	23	4017166543971	

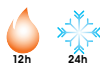



ISOLIERFLASCHE COLORE

500 ML

Edelstahl satiniert oder lackiert, mit Doppelwandsystem, bruch- und auslaufsicher, Schraubverschluss mit praktischer Einhand-Ausgießtaste, mit Trinkbecher, Inhalt: 500 ml

INSULATED BOTTLE COLORE. Stainless steel satin finish or lacquered, with double wall system, break and leak proof, screw cap with useful push button for pouring, incl. mug, capacity: 500 ml

Art.-Nr.	Farbe	Ø	Höhe cm	EAN	
543247	satiniert/satin finish	7	25	4017166543247	
543353	metallic rot/red	7	25	4017166543353	
543384	metallic schwarz/black	7	25	4017166543384	

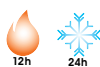

ISOLIERFLASCHE COLORE

750 ML

Edelstahl satiniert oder lackiert, mit Doppelwandsystem, bruch- und auslaufsicher, Schraubverschluss mit praktischer Einhand-Ausgießtaste, mit Trinkbecher, Inhalt: 750 ml

INSULATED BOTTLE COLORE. Stainless steel satin finish or lacquered, with double wall system, break and leak proof, screw cap with useful push button for pouring, incl. mug, capacity: 750 ml

Art.-Nr.	Farbe	Ø	Höhe cm	EAN	
543254	satiniert/satin finish	7,5	28	4017166543254	
543360	metallic rot/red	7,5	28	4017166543360	
543391	metallic schwarz/black	7,5	28	4017166543391	



ISOLIERFLASCHE COLORE

1 L

Edelstahl satiniert oder lackiert, mit Doppelwandsystem, bruch- und auslaufsicher, Schraubverschluss mit praktischer Einhand-Ausgießtaste, mit Trinkbecher, Inhalt: 1L

INSULATED BOTTLE COLORE. Stainless steel satin finish or lacquered, with double wall system, break and leak proof, screw cap with useful push button for pouring, incl. mug, capacity: 1L

Art.-Nr.	Farbe	Ø	Höhe cm	EAN	
543261	satiniert/satin finish	8	32	4017166543261	
543377	metallic rot/red	8	32	4017166543377	
543407	metallic schwarz/black	8	32	4017166543407	

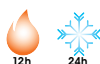

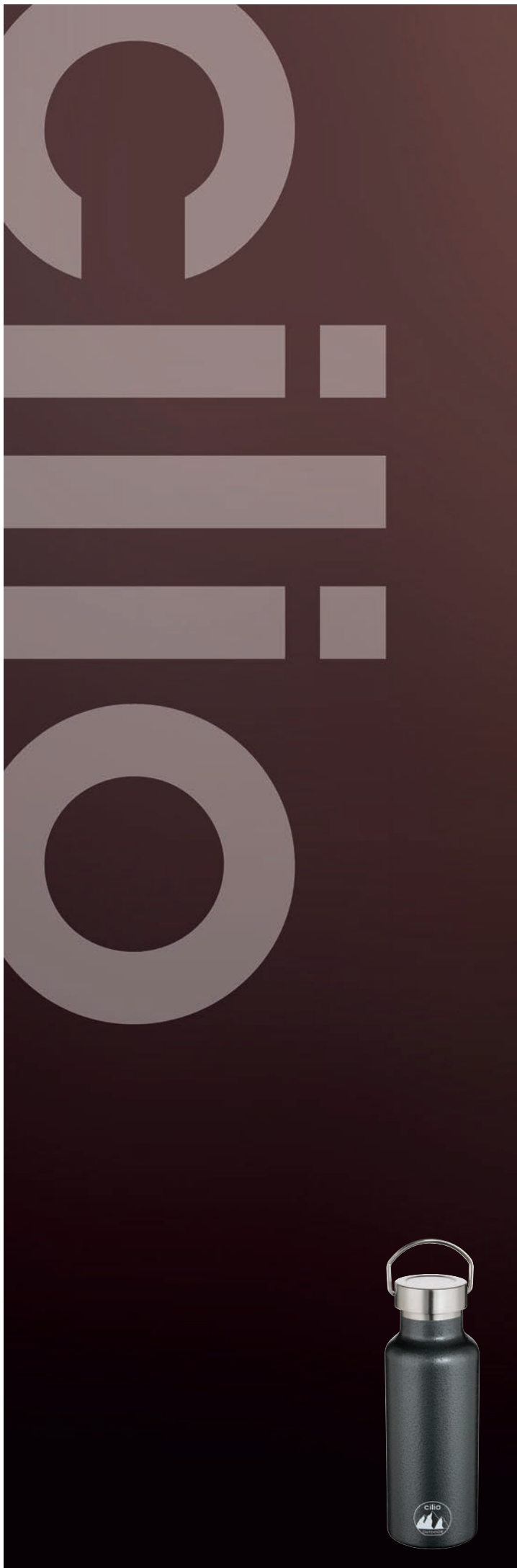

ISOLIERTRINKFLASCHE
GRIGIO
auslaufsicher, 500 ml und 750 ml

cilio

ISOLIERTRINKFLASCHE GRIGIO

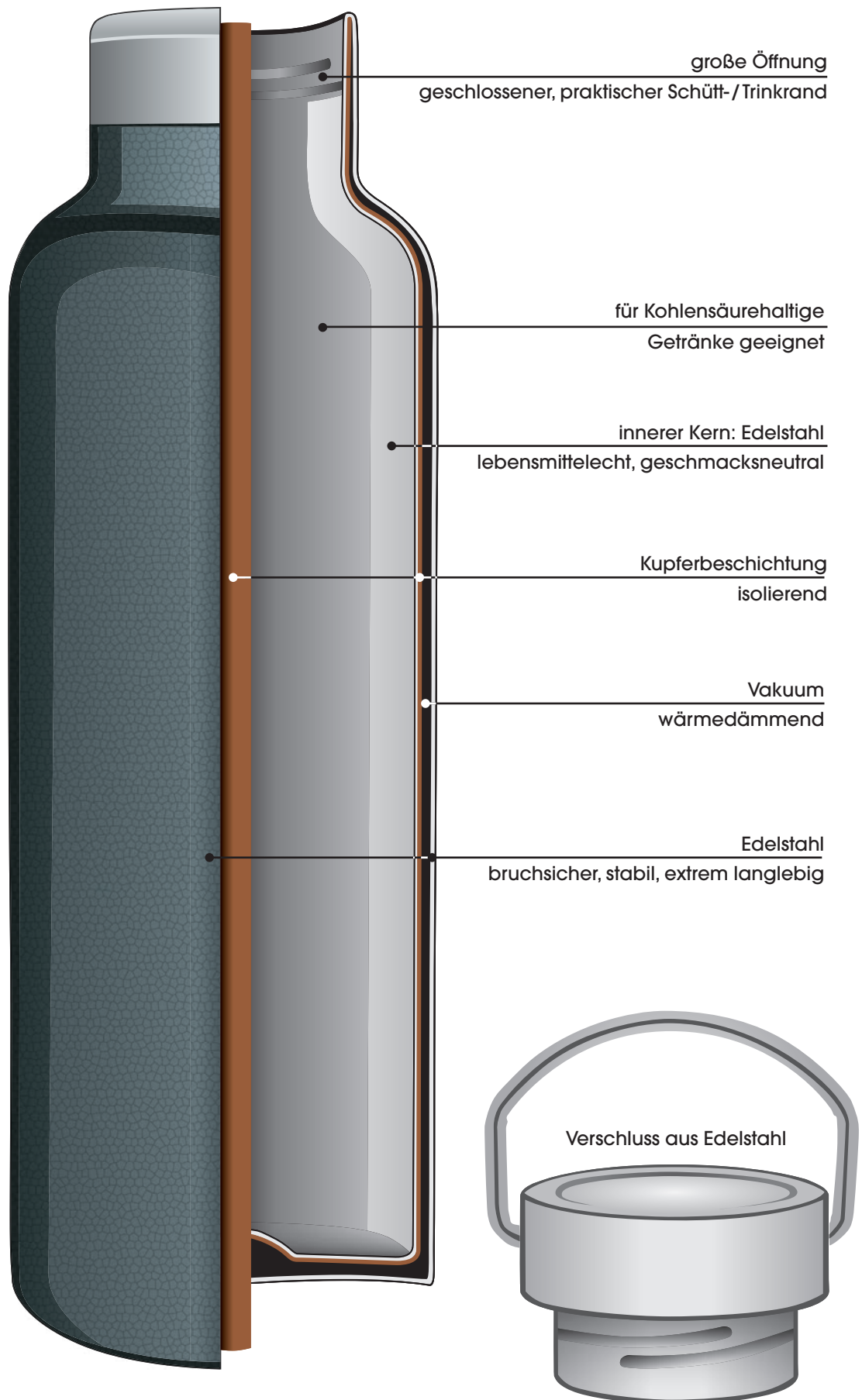

ISOLIERFLASCHE MONTE

Edelstahl lackiert, mit Doppelwandsystem, bruch- und auslaufsicher, Schraubverschluss, mit praktischer Einhand-Ausgießtaste, Verschluss zum Reinigen zerlegbar, inkl. Trinkbecher

INSULATED BOTTLE MONTE. Lacquered stainless steel, with double wall system, break and leak proof, screw cap with useful push button for pouring, demountable cap for easy cleaning, incl. mug

Art.-Nr.	Inhalt	Ø	Höhe cm	EAN	
545500	500 ml	7,5	25,5	4017166545500	
545517	750 ml	9	28	4017166545517	
545487	1 L	8,5	32,5	4017166545487	



ISOLIERTRINKFLASCHE GRIGIO

Edelstahl lackiert, Doppelwandsystem mit Kupferbeschichtung, bruch- und auslaufsicher, Schraubverschluss, mit praktischem Griff am Deckel

INSULATED DRINKING BOTTLE GRIGIO. Lacquered stainless steel, double wall system with copper coating, break and leak proof, screw cap, with useful handle on the lid

Art.-Nr.	Inhalt	Ø	Höhe cm	EAN	
545623	500 ml	7	20,5	4017166545623	
545630	750 ml	7,5	25	4017166545630	



FELDFLASCHE MONTE

700 ML

Edelstahl lackiert, mit Doppelwandsystem, auslauf- und bruchsicher, verstellbarer Trageriemen, Schraubverschluss mit integriertem Kompass

CANTEEN FLASK MONTE. Lacquered stainless steel, with double wall system, break and leak proof, with adjustable carrying strap, screw cap with integrated compass

Art.-Nr.	Inhalt	Größe cm	EAN	
545609	700 ml	15,5 x 8 x 21	4017166545609	



Es geht auch anders! Trendig & Nachhaltig

Damit die Verschwendung von Ressourcen ein Ende hat, wird das Befüllen von wiederverwendbaren Coffe To Go-Bechern bereits in vielen Bäckereien honoriert. Doch warum nur beim Thema Kaffee und nur beim Müll?

Für Wasser fahren zehntausende LKW quer durch Europa – und zwar täglich. Doch das muss nicht sein. Leitungswasser ist in Deutschland sowie vielen anderen europäischen Staaten von ausgezeichneter Qualität, so dass sich der tägliche Bedarf an Trinkwasser schnell, umweltfreundlich und für wenige Cent stillen lässt.

Und **cilio** hat die Isolierflasche ELEGANTE.

Robust, auslaufsicher und zudem auch für kohlenstoffhaltige Getränke geeignet, ist die Isolierflasche ein zuverlässiger Begleiter, wenn man bei der Arbeit, unterwegs oder im Urlaub ist. Dank einer besonders isolierenden Kupferschicht hält sie Leitungswasser und Sprudel, aber auch hausgemachte Limonaden oder Smoothies als Erfrischungen für unterwegs bis zu 24 Stunden kalt. Und falls es mal etwas zum Aufwärmen sein soll – heiße Getränke bleiben bis zu 18 Stunden heiß. Das nennen wir von **cilio** den Mehrwegfaktor!

Trinken muss jeder – mit der Isolierflasche ELEGANTE geht das klimafreundlich, nachhaltig und mit Stil.

There is another way! Trendy & Sustainable

To find an end of the waste of resources, the filling of reusable Coffe To Go cups is already rewarded in many bakeries. But why in terms of coffee and garbage only?

Tens of thousands of trucks are driving across Europe for water - every day. But this is not necessary. Tap water is of excellent quality in Germany and many other European countries, so that the daily need for drinking water can be quenched quickly, environmentally friendly and for a few cents.

And **cilio** has the vacuum flask ELEGANTE.

Robust, leak-proof and also suitable for carbonated drinks, the vacuum flask is a reliable companion when you are at work, on the move or on vacation. Thanks to a particularly insulating copper layer, it keeps tap water and sparkling water, as well as homemade lemonades or smoothies as refreshments on the go cold for up to 24 hours. And if it has to be something to warm up - hot drinks stay hot for up to 18 hours. We call this the reusable factor of **cilio**!

Everyone has to drink - with the insulated bottle ELEGANTE, you can do this climate friendly, sustainable and with style.

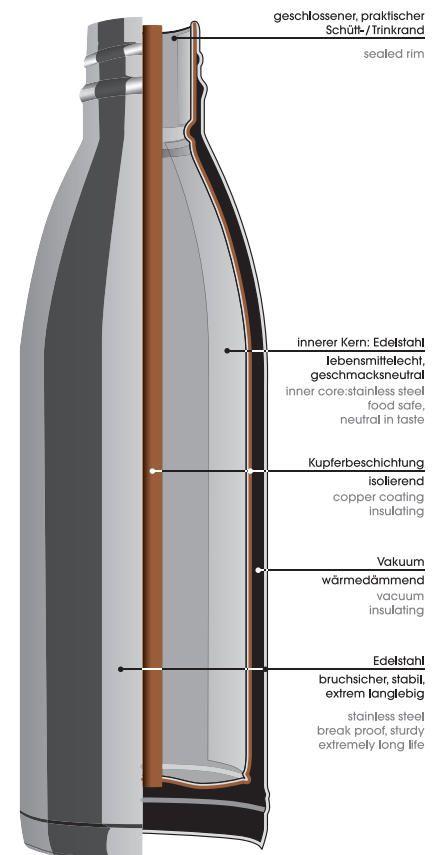

ISOLIERTRINKFLASCHE ELEGANTE

500 ML

Edelstahl satiniert oder lackiert, Doppelwandsystem mit Kupferbeschichtung, bruch-sicher, auslaufsicher, Schraubverschluss, geeignet für kohlenensäurehaltige Getränke, Inhalt: 500 ml

INSULATED DRINKING BOTTLE ELEGANTE. Stainless steel satin finish or lacquered, double wall system with copper coating, break and leak proof, screw cap, suitable for carbonated beverages, capacity: 500 ml

Art.-Nr.	Farbe	Ø	Höhe cm	EAN	
543414	satiniert/satin finish	6,5	26	4017166543414	
543421	metallic rot/metallic red	6,5	26	4017166543421	
543438	metallic schwarz/ metallic black	6,5	26	4017166543438	

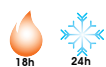

ISOLIERTRINKFLASCHE ELEGANTE

750 ML

Edelstahl satiniert oder lackiert, Doppelwandsystem mit Kupferbeschichtung, bruch-sicher, auslaufsicher, Schraubverschluss, geeignet für kohlenensäurehaltige Getränke, Inhalt: 750 ml

INSULATED DRINKING BOTTLE ELEGANTE. Stainless steel satin finish or lacquered, double wall system with copper coating, break and leak proof, screw cap, suitable for carbonated beverages, capacity: 750 ml

Art.-Nr.	Farbe	Ø	Höhe cm	EAN	
543445	satiniert/satin finished	7,5	30	4017166543445	
543452	metallic rot/metallic red	7,5	30	4017166543452	
543469	metallic schwarz/ metallic black	7,5	30	4017166543469	

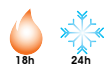

ISOLIERTRINKFLASCHE ELEGANTE

1 L

Edelstahl satiniert oder lackiert, Doppelwandsystem mit Kupferbeschichtung, bruch-sicher, auslaufsicher, Schraubverschluss, geeignet für kohlenensäurehaltige Getränke, Inhalt: 1 L

INSULATED DRINKING BOTTLE ELEGANTE. Stainless steel satin finish or lacquered, double wall system with copper coating, break and leak proof, screw cap, suitable for carbonated beverages, capacity: 1 L

Art.-Nr.	Farbe	Ø	Höhe cm	EAN	
543537	satiniert/satin finished	9	32	4017166543537	
543544	metallic rot/metallic red	9	32	4017166543544	
543551	metallic schwarz/ metallic black	9	32	4017166543551	

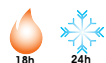

ISOLIERTRINKBECHER LATTINA

Edelstahl rostfrei lackiert, mit Doppelwandsystem, bruch- und auslaufsicher, geeignet für kohensäurehaltige Getränke, Inhalt: 500 ml

INSULATED DRINKING MUG LATTINA. Lacquered stainless steel, with double wall system, break and leak proof, suitable for carbonated beverages, capacity: 500 ml

Art.-Nr.	Farbe	Ø	Höhe cm	EAN	
543803	blau/blue	7	19	4017166543803	
543810	rot/red	7	19	4017166543810	
543827	lila/purple	7	19	4017166543827	



ISOLIERTRINKBECHER

Edelstahl satiniert, mit hochwertigem schwarzen Kunststoff, mit Doppelwandsystem, bruchstabil, passend für alle gängigen Becherhalter, Inhalt: 400 ml

INSULATED DRINKING MUG. Stainless steel satin finish, with high-quality black plastics, with double wall system, break proof, suitable for all common cup holder, capacity: 400 ml

Art.-Nr.		Ø	Höhe cm	EAN	
541021	1	8,5	17,5	4017166541021	
Art.-Nr.		Ø	Höhe cm	EAN	
542196	2 TRENDY	7	19	4017166542196	



ISOLIERTRINKBECHER

Edelstahl satiniert, mit hochwertigem schwarzen Kunststoff, mit Doppelwandsystem, auslauf- und bruchstabil, 360° Trinkverschluss, zum Reinigen zerlegbar, Inhalt: 350 ml

INSULATED DRINKING MUG. Stainless steel satin finish, with high-quality black plastics, with double wall system, break and leak proof, 360° drinking lid, demountable for easy cleaning, capacity: 350 ml

Art.-Nr.		Ø	Höhe cm	EAN	
545081	1 MONDO	8	19	4017166545081	
Art.-Nr.		Ø	Höhe cm	EAN	
545005	2 PERFETTA	7	18	4017166545005	



FOOD CONTAINER MONTE

Edelstahl lackiert, mit Doppelwandsystem, bruch- und auslaufsicher, Schraubverschluss, inkl. klappbarem Löffel aus Edelstahl

Lacquered stainless steel. With double wall system, break and leak proof, screw cap, incl. foldable spoon made of stainless steel

Art.-Nr.	Inhalt	Ø	Höhe cm	EAN	
545524	500 ml	9,5	15,5	4017166545524	
545616	750 ml	9	20	4017166545616	



LUNCH BOX COOL

Hochwertiger Kunststoff, BPA-frei, herausnehmbarer Kühlakku, mit Unterteilung und 2 separaten Einsätzen, inkl. Gabel und Löffel (praktische Aufbewahrung im Deckel), mikrowellenfest, gefrierfest bis -20°C

LUNCH BOX COOL. High-quality plastics, BPA free, removable cool pack, with divider and 2 separate containers, incl. fork and spoon (usefully stored inside the lid), suitable for microwave and freezer up to -20°C

Art.-Nr.	Volumen	Größe cm	EAN
158403	1,5 L	22 x 16,5 x 9	4017166158403



LUNCH BOX FRESH

Hochwertiger Kunststoff, BPA-frei, herausnehmbarer Kühl-Akku, mit separatem 2-fach unterteilten Einsatz und Dressingbehälter (75 ml) mit Schraubdeckel, inkl. Gabel und Löffel (praktische Aufbewahrung im Deckel), mikrowellenfest, gefrierfest bis -20°C

LUNCH BOX FRESH. High-quality plastics, BPA free, removable cool pack, with separate, double divided insert and dressing container (75 ml) with screw cap, incl. fork and spoon (usefully stored inside the lid), suitable for microwave and freezer up to -20°C

Art.-Nr.	Volumen	Größe cm	EAN
158410	Behälter 1,5 L	18 x 18 x 11	4017166158410
	Dressingbehälter 75 ml		



cilio

Würzen

Holen Sie sich den Duft Italiens nach Hause – Rosmarin, Thymian, Basilikum, Knoblauch – im Mörser grob zerstoßen eröffnen diese Klassiker der Italienische Küche völlig neue Genussmomente. Das Aroma kann sich voll entfalten und bietet ein herausragendes Geschmackerlebnis.

Die Mörser von **cilio** aus Marmor oder Granit bringen mediterranes Flair in jedes zuhause.

Season

Bring the scent of Italy home - rosemary, thyme, basil, garlic - roughly crushed in a mortar, these classics of Italian cuisine open up completely new moments of enjoyment. The flavour can fully develop and offers an outstanding taste experience.

The marble or granite **cilio** mortars bring a Mediterranean flair to any home.



MÖRSE R MARS UND JUPITER

Marmor, elfenbein-/champagnerfarben strukturiert, hochglanzpoliert, abriebfest und säureresistent, inkl. Stößel

MORTAR MARS & JUPITER. Ivory/champagne coloured marble, mirror polished, resistant to abrasion and acid, incl. pestle

Art.-Nr.		Ø	Höhe	Gewicht kg	EAN	
422009	1 Mars	9	5	0,5	4017166422009	
422016	2 Jupiter	13	9	2	4017166422016	



1 + 2

MÖRSE R EROS, SALOMON UND ATLAS

Granit, abriebfest und säureresistent, inkl. Stößel

MORTAR EROS, SALOMON & ATLAS. Granite, resistant to abrasion and acid, incl. pestle

Art.-Nr.		Ø	Höhe	Gewicht kg	EAN	
420814	1 Eros	11,5	9	1,3	4017166420814	
420197	2 Salomon	14	10	2,4	4017166420197	
420203	3 Atlas	19	13	6,1	4017166420203	



1

2 + 3

MÖRSE R PLUTOS, DAVID UND GOLIATH

Granit, abriebfest und säureresistent, inkl. Stößel

MORTAR PLUTOS, DAVID & GOLIATH. Granite, resistant to abrasion and acid, incl. pestle

Art.-Nr.		Ø	Höhe	Gewicht kg	EAN	
420807	1 Plutos	10	9,5	1,4	4017166420807	
420135	2 David	14	9,5	2,7	4017166420135	
420128	3 Goliath	19	13	6,4	4017166420128	



1

2 + 3

MÖRSE R GIGANT

Granit, abriebfest und säureresistent, inkl. Stößel

MORTAR GIGANT. Granite, resistant to abrasion and acid, incl. pestle

Art.-Nr.		Ø	Höhe	Gewicht kg	EAN	
420142	Gigant	22	10,5	6	4017166420142	



Geschichte

Gewürze sind aus unserer Küche nicht mehr wegzudenken - sie bieten eine nahezu unerschöpfliche Geschmacksvielfalt. Je nach Gewürz entsteht aus einfachen Basiszutaten ein komplett neues Gericht.

Doch das war nicht immer so. Gewürze waren der Antrieb für wagemutige Exkursionen, und die Blütezeit vieler Länder war dem Gewürzhandel zu verdanken.

Zu den Zeiten der berühmten italienischen Entdecker wurde Pfeffer in Gold aufgewogen und war auch als Mitgift gern gesehen. Nur den Adligen standen exotische Gewürze zur Verfügung, die allerdings sehr verschwenderisch damit umgingen. Um ihren Reichtum und ihre Macht zu demonstrieren und die Gäste zu beeindrucken, wurde der Geschmack der Speisen vollständig von Gewürzen überdeckt.

Zum Glück sind diese Zeiten lange vorbei. Gewürze und Kräuter sind heute kein Statussymbol mehr.

Heutzutage zeugen Kräuter und Gewürze von kreativer Küche, gesundheitsbewusster Ernährung und Lust am Genuss. Frisch gemahlen oder in Öl als Würzpaste sind die Einsatzmöglichkeiten vielfältig und sorgen für Abwechslung. Dank durchdachter Produkte von **cilio** gibt es für jeden Bedarf das richtige Accessoire – nicht nur beim Zubereiten in der Küche, sondern auch bei Tisch zum individuellen Servieren oder Nachwürzen.

History

Spices are an indispensable part of our kitchen - they offer an almost inexhaustible variety of flavours. Depending on the spice, simple basic ingredients can be used to create a completely new dish.

But that was not always the case. Spices were the impulse for daring excursions, and the height of many countries was due to the spice trade.

In the days of the famous Italian explorers pepper was outweighed in gold and was also welcome as a dowry. Only the nobles had exotic spices available, but they handled it very lavishly. In order to demonstrate their wealth and power and to impress the guests, the flavour of the food was completely covered in spices.

Luckily these times are long gone. Spices and herbs are no longer a status symbol today.

Nowadays, herbs and spices are the evidence for a creative cuisine, health-conscious nutrition and pleasure in enjoyment. Freshly ground or in oil as a seasoning paste, the application possibilities are versatile and provide variety. Thanks to sophisticated products from **cilio**, there is the right accessory for every need - not only when cooking in the kitchen, but also at the table for individual serving or seasoning.



PFEFFER- UND SALZMÜHLE BRINDISI

Glas / Edelstahl satiniert, extra hartes, stufenlos verstellbares Keramik-Mahlwerk, abriebfest und korrosionsfrei, auch für getrocknete Kräuter geeignet, mit Verschlusskappe für sauberes Arbeiten und Aufbewahren, inkl. beschreibbaren Aufklebern, passende Vorratsgläser mit Deckel, als praktisches 2er Set separat erhältlich, 10 Jahre Garantie auf das Mahlwerk

PEPPER AND SALT MILL BRINDISI. Glass / stainless steel satin finish, extra hard, continuously adjustable grinding mechanism, resistant to abrasion and corrosion free, also perfect for dried herbs, with cover cap for clean working and storage, incl. writable labels, suitable storage jars with lid, as a useful set of 2 pieces separately available, 10 years guarantee on the grinding mechanism

Art.-Nr.		Ø	Höhe cm	EAN	
613308	PM	6,5	14	4017166613308	
613315	SM	6,5	14	4017166613315	
613278	Vorratsgläser/storage jars			4017166613278	

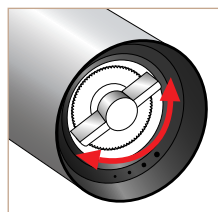

PFEFFER- UND SALZMÜHLE BARI

Glas / Edelstahl satiniert, extra hartes, stufenlos verstellbares Keramik-Mahlwerk, abriebfest und korrosionsfrei, auch für getrocknete Kräuter geeignet, mit Verschlusskappe für sauberes Arbeiten und Aufbewahren, inkl. beschreibbaren Aufklebern, passende Vorratsgläser mit Deckel, als praktisches 2er Set separat erhältlich, 10 Jahre Garantie auf das Mahlwerk

PEPPER AND SALT MILL BARI. Glass / stainless steel satin finish, extra hard, continuously adjustable grinding mechanism, resistant to abrasion and corrosion free, also perfect for dried herbs, with cover cap for clean working and storage, incl. writable labels, suitable storage jars with lid, as a useful set of 2 pieces separately available, 10 years guarantee on the grinding mechanism

Art.-Nr.		Ø	Höhe cm	EAN	
613285	PM	5	14	4017166613285	
613292	SM	5	14	4017166613292	
613346	Vorratsgläser/storage jars			4017166613346	

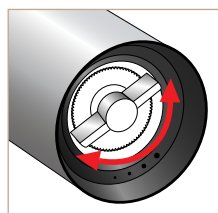

PFEFFER- UND SALZMÜHLE GENOVA

Acryl, extra hartes, stufenlos verstellbares Keramik-Mahlwerk, abriebfest und korrosionsfrei, auch für getrocknete Kräuter geeignet, 25 Jahre Garantie auf das Mahlwerk

PEPPER AND SALT MILL GENOVA. Acrylic, extra hard, continuously adjustable grinding mechanism, resistant to abrasion and corrosion free, also perfect for dried herbs, 25 years guarantee on the grinding mechanism

Art.-Nr.		Höhe cm	EAN
600162	PM	14	4017166600162
600179	SM	14	4017166600179
600186	PM rot/red	14	4017166600186
600247	PM grün/green	14	4017166600247
600261	PM Edelstahl satiniert/stainless steel satin finish	14	4017166600261
600278	SM Edelstahl satiniert/stainless steel satin finish	14	4017166600278



PM: Pfeffermühle / pepper mill | SM: Salzmühle / salt mill

PFEFFER- UND SALZMÜHLE ROMA

Holz, marone gebeizt, extra hartes, stufenlos verstellbares Keramik-Mahlwerk, abriebfest und korrosionsfrei, auch für getrocknete Kräuter geeignet, 25 Jahre Garantie auf das Mahlwerk

PEPPER AND SALT MILL ROMA. Wood, chestnut stained, extra hard, continuously adjustable grinding mechanism, resistant to abrasion and corrosion free, also perfect for dried herbs, 25 years guarantee on the grinding mechanism

Art.-Nr.		Höhe cm	EAN
603569	PM	18	4017166603569
603576	SM	18	4017166603576
603583	PM	22	4017166603583
603590	SM	22	4017166603590
603606	PM	30	4017166603606
603613	SM	30	4017166603613
603620	PM	40	4017166603620
603637	SM	40	4017166603637



PM: Pfeffermühle / pepper mill | SM: Salzmühle / salt mill

cilio



PFEFFER- UND SALZMÜHLE BERGAMO

ELEKTRISCH

Edelstahl satiniert, extra hartes, stufenlos verstellbares Keramik-Mahlwerk, abriebfest und korrosionsfrei, auch für getrocknete Kräuter geeignet, mit LED-Licht, mit Verschlusskappe für sauberes Arbeiten und Aufbewahren, inkl. 8 Alkaline-Batterien Typ 1,5V (AA),

PEPPER AND SALT MILL BERGAMO. Stainless steel satin finish, extra hard, continuously adjustable grinding mechanism, resistant to abrasion and corrossions free, also perfect for dried herbs, with LED light, with cover cap for clean working and storage, incl. 8 alkaline batteries type 1,5V (AA)

Art.-Nr.	Ø	Höhe cm	EAN
615005	5	23	4017166615005

MUSKATMÜHLE COMO

Acryl

NUTMEG MILL COMO. Acrylic



Art.-Nr.	Höhe cm	EAN
609707	9	401716609707

CHILIMÜHLE PICCANTE

Glas / Edelstahl satiniert, spezielle Schneidetechnik für gleichmäßige Chiliflocken im oberen Teil des Gehäuses, mit Verschlusskappe für sauberes Arbeiten und Aufbewahren, inkl. beschreibbaren Aufklebern, 10 Jahre Garantie auf die Schneidetechnik

CHILI MILL PICCANTE. Glass / stainless steel satin finish, special cutting mechanism for uniformly fine chili flakes, with cover cap for clean working and storage, incl. writable labels, 10 years guarantee on the cutting mechanism



Art.-Nr.	Ø	Höhe cm	EAN
613018	6,5	14,5	4017166613018



Produkt in Geschenkverpackung | Product in gifftbox = 

Trattoria "da mamma"

STREUER TAVOLA

Edelstahl poliert / Glas, Inhalt: 100 ml

DREDGER TAVOLA. Stainless steel mirror polished / glass, capacity: 100 ml

Art.-Nr.		Ø	Höhe	EAN	
550528	Grobsteuer/coarse dredger	5	8	4017166550528	
550542	Feinsteuer/fine dredger	5	8	4017166550542	
550535	Netzsteuer/net dredger	5	8	4017166550535	



MENAGE TAVOLA

Edelstahl satiniert / Glas / Edelstahl poliert, Inhalt: Streuer je 75 ml, Flaschen je 150 ml

CRUET SET TAVOLA. Stainless steel satin finish / glass / stainless steel mirror polish, capacity: dredger 75 ml each, bottles 150 ml each

Art.-Nr.		Größe cm	EAN	
550566	2-teilig/2 pieces	12,5 x 6 x 16,5	4017166550566	
550559	4-teilig/4 pieces	24,5 x 7 x 22,5	4017166550559	



Produkt in Geschenkverpackung | Product in giftbox = 



MENAGE MINI

Edelstahl satiniert, mit Ständer

CRUET SET MINI. Stainless steel satin finish, with stand

Art.-Nr.		Höhe cm	EAN	
300611	2-teilig/set of 2 pieces	12,5 x 9,0	4017166300611	

STREUER MINI

Edelstahl satiniert

DREDGER MINI. Stainless steel satin finish



Art.-Nr.		Ø	Höhe	EAN	
300376	Pfeffersteuer/pepper shaker	3,5	4,5	4017166300376	
300383	Salzsteuer/salt shaker	3,5	4,5	4017166300383	
300390	Netzsteuer/net dredger	3,5	4,5	4017166300390	

STREUER MIDI

Edelstahl satiniert

DREDGER MIDI. Stainless steel satin finish



Art.-Nr.		Ø	Höhe	EAN	
300451	Pfeffersteuer/pepper shaker	3,5	10	4017166300451	
300444	Salzsteuer/salt shaker	3,5	10	4017166300444	
300437	Netzsteuer/net dredger	3,5	10	4017166300437	

AUSGIESSER MEZZO

Edelstahl poliert / Silikon, passend für Flaschenöffnungen 16 – 20 mm, mit Luftrückführung für perfektes Dosieren, geeignet für Öl, Essig oder Spirituosen, 2 Stück im Set
POURER MEZZO. Stainless steel, mirror polished, suitable for bottle openings 16 – 20 mm, with air recirculation for even pouring, perfect for oil, vinegar or spirits, set of 2 pieces

Art.-Nr.		Ø	Höhe cm	EAN	
107180		0,9	8,5	4017166107180	



ÖLFLASCHE MEZZO

Keramik / Edelstahl poliert, inkl. Aufkleber für Öl und Essig in 9 Sprachen, Ausgießer mit Luftrückführung für perfektes Dosieren

OIL BOTTLE MEZZO. Ceramics / stainless steel mirror polish, incl. labels oil and vinegar in 9 languages, pourer with air recirculation for even pouring

Art.-Nr.	Inhalt	Höhe cm	EAN	
107135	500 ml	6 x 6 x 30,5	4017166107135	
107166	350 ml	6 x 6 x 19	4017166107166	



ÖLKANNE OLIO OLIVA

Edelstahl poliert

OIL DRIZZLER OLIO OLIVA. Stainless steel mirror polished

Art.-Nr.	Inhalt	Größe cm	EAN
311044	500 ml	21,5 x 6 x 15	4017166311044



ÖLKANNE OLIO VERDE

Edelstahl poliert

OIL DRIZZLER OLIO VERDE. Stainless steel mirror polished

Art.-Nr.	Inhalt	Größe cm	EAN
311051	500 ml	21,5 x 6 x 15	4017166311051



ÖLKANNE OLIO PURO

Edelstahl poliert

OIL DRIZZLER OLIO PURO. Stainless steel mirror polished

Art.-Nr.	Inhalt	Größe cm	EAN
311075	500 ml	21,5 x 6 x 15	4017166311075



Olivenholz - Edel und schön.

Hier ist der Name Programm. Olivenholz ist der Inbegriff für italienisches Flair. Jedes Stück ist ein Unikat, einzeln und in Handarbeit gefertigt, aus Holz von bis zu 500 Jahre alten Olivenbäumen, die keine Früchte mehr tragen. Die typische Maserung unterstreicht den individuellen Charakter und die Haptik schmeichelt der Hand. So macht nicht nur das Servieren Spaß, sondern auch schon das Zubereiten.

Olivenholzkunde

Olivenbäume wachsen äußerst langsam und entwickeln daher ein besonders hartes und dichtes Holz. Durch diese Eigenschaft ist das Holz äußerst schnittfest und resistent gegen Säuren, Fette oder Bakterien und nimmt keine Gerüche an.

Olive wood - noble and beautiful.

Here, the name speaks for itself. Olive wood is the epitome of Italian flair. Each piece is unique, individually and handcrafted, made of wood from up to 500 years old olive trees that bear no fruits anymore. The typical grain emphasizes the individual character and the touch flatters the hand. So not only the serving is fun, but also the preparation..

Good to know

Olive trees grow extremely slowly and therefore develop a particularly hard and dense wood. This property makes the wood extremely cut-resistant and resistant to acids, fats or bacteria, moreover it does not absorb odors.



KOLLEKTION TOSCANA

Olivenholz, einzeln in Handarbeit gefertigt, mit Sonnenblumenöl geölt
 COLLECTION TOSCANA. Olive wood, handcrafted, oiled with sunflower oil

Art.-Nr.		Länge cm	EAN	
182095	Honigportionierer/honey server	16	4017166182095	
182002	Rührlöffel/spoon	30	4017166182002	
182026	Kochlöffel/cooking spoon	25	4017166182026	



KOLLEKTION TOSCANA

Olivenholz, einzeln in Handarbeit gefertigt, mit Sonnenblumenöl geölt
 COLLECTION TOSCANA. Olive wood, handcrafted, oiled with sunflower oil

Art.-Nr.		Länge cm	EAN	
182033	Kochlöffel/cooking spoon	30	4017166182033	
182132	Kochlöffel mit Loch/cooking spoon with hole	30	4017166182132	
182057	Wender/turner	30	4017166182057	



KOLLEKTION TOSCANA

Olivenholz, einzeln in Handarbeit gefertigt, mit Sonnenblumenöl geölt
 COLLECTION TOSCANA. Olive wood, handcrafted, oiled with sunflower oil

Art.-Nr.		Länge cm	EAN	
182064	Wender gelocht/turner with holes	30	4017166182064	
182071	Wok-Wender/wok turner	30	4017166182071	
182125	Salatbesteck/salad set	30	4017166182125	



SERVIERPLATTE FORMAGGIO

Feuerfestes Hartporzellan, bei ca. 1300°C gebrannt

SERVING PLATTER FORMAGGIO. Fire-proof hard porcelain, burnt at approx. 1.300°C



Art.-Nr.		Ø	Größe cm	EAN	
296587	mit 2 Griffen / with 2 handles	26		4017166296587	
296594	mit Griff / with handle		20,5 x 30,5	4017166296594	

VORRATSDOSE FORMAGGIO

Feuerfestes Hartporzellan, bei ca. 1300°C gebrannt

STORAGE CONTAINER FORMAGGIO. Fire-proof hard porcelain, burnt at approx. 1.300°C



Art.-Nr.		Ø	Höhe cm	EAN	
296570		13	6	4017166296570	



Produkt in Geschenkverpackung | Product in giftbox = 

SERVIERPLATTE FORMAGGIO

Schiefer mit gebrochenen Kanten, oberflächenschonende GummifüÙe

SERVING PLATTER FORMAGGIO. Slate with chamfered edges, surface-friendly rubber feet

Art.-Nr.		Ø	Größe cm	EAN
296716	mit Griff / with handle	22	22 x 30	4017166296716
296723	quadratisch / square		20 x 20	4017166296723



SERVIERPLATTE FORMAGGIO

Schiefer mit gebrochenen Kanten, oberflächenschonende GummifüÙe

SERVING PLATTER FORMAGGIO. Slate with chamfered edges, surface-friendly rubber feet

Art.-Nr.		Ø	Größe cm	EAN
296556	rund / round	30		4017166296556
296549	rechteckig / rectangular		30 x 20	4017166296549



SERVIERBRETT MIT SCHIEFERPLATTE FORMAGGIO

Eichenholz / Schiefer mit gebrochenen Kanten

SERVING BOARD WITH SLATE PLATTER FORMAGGIO. Oak wood / slate with chamfered edges

Art.-Nr.		Größe cm	EAN
296730	quadratisch / square	23 x 23	4017166296730
296747	rechteckig / rectangular	33 x 23	4017166296747





KÄSEMESSER FORMAGGIO

Edelstahl satiniert, Griff aus Eichenholz, Set bestehend aus Parmesanbrecher, Butter-/ Schmierkäsemesser, Käsegabel

CHEESE KNIVES FORMAGGIO. Stainless steel satin finish, oak wood handle, set consists of Parmesan cheese knife, butter/cream cheese knife, cheese fork

Art.-Nr.	Größe cm	EAN
296679	3-teilig/3 pieces	4017166296679



KÄSEMESSER FORMAGGIO

Edelstahl satiniert, Griff aus Eichenholz, Set bestehend aus Käsebeil, Hartkäsemesser

CHEESE KNIVES FORMAGGIO. Stainless steel satin finish, oak wood handle, set consists of hard cheese knife, cheese hatchet

Art.-Nr.	Größe cm	EAN
296686	2-teilig/2 pieces	4017166296686



KÄSEMESSER FORMAGGIO

Edelstahl satiniert, Griff aus Porzellan, Set bestehend aus Parmesanbrecher, Hartkäsemesser, Käsegabel, Weichkäsemesser

CHEESE KNIVES FORMAGGIO. Stainless steel satin finish, porcelain handles, set consists of Parmesan cheese knife, hard cheese knife, cheese fork, soft cheese knife

Art.-Nr.	Größe cm	EAN
296662	4-teilig/4 pieces	4017166296662



KÄSEMESSER FORMAGGIO

Edelstahl satiniert, Griff aus Eichenholz, Set bestehend aus Parmesanbrecher, Hartkäsemesser, Käsegabel, Weichkäsemesser

CHEESE KNIVES FORMAGGIO. Stainless steel satin finish, oak wood handle, set consists of Parmesan cheese knife, hard cheese knife, cheese fork, soft cheese knife

Art.-Nr.		Größe cm	EAN	
296693	4-teilig/4 pieces	14	4017166296693	



KÄSEMESSER PIAVE FORMAGGIO

Edelstahl satiniert, Set bestehend aus: Hartkäsemesser, Weichkäsemesser, Parmesanbrecher und Käsegabel, in Holz-Geschenkbox 23 x 17 x 4 cm

CHEESE KNIVES PIAVE FORMAGGIO. Stainless steel satin finish set consists of Parmesan cheese knife, hard cheese knife, cheese fork, soft cheese knife, in wooden gift box 23 x 17 x 4 cm

Art.-Nr.		Größe cm	EAN	
294804	4-teilig/4 pieces	12,5	4017166294804	



KÄSEMESSER FONTINA FORMAGGIO

Edelstahl satiniert, Griff aus PAKKA-Holz, Set bestehend aus Hartkäsemesser, Weichkäsemesser, Parmesanbrecher, in Holz-Geschenkbox 28,5 x 13,5 x 4 cm

CHEESE KNIVES FONTINA FORMAGGIO. Stainless steel satin finish, pakka wood handle, set consists of hard cheese knife, soft cheese knife, Parmesan cheese knife, in wooden gift box 28,5 x 13,5 x 4 cm

Art.-Nr.		Größe cm	EAN	
294200	3-teilig/3 pieces	20,5-21,5-25	4017166294200	





KÄSEMESSER FORMAGGIO

Edelstahl satiniert, Griff aus Eichenholz
CHEESE KNIFE FORMAGGIO. Stainless steel satin finish, oak wood handle

Art.-Nr.	Länge cm	EAN	
296617	28	4017166296617	



KÄSEHOBEL FORMAGGIO

Edelstahl satiniert, Griff aus Eichenholz
CHEESE SLICER FORMAGGIO. Stainless steel satin finish, oak wood handle

Art.-Nr.	Breite cm	Länge cm	EAN	
296624	7,5	23	4017166296624	



KÄSEMESSER FORMAGGIO

Edelstahl satiniert, Griff aus Eichenholz
CHEESE KNIFE FORMAGGIO. Stainless steel satin finish, oak wood handle

Art.-Nr.	Länge cm	EAN	
296631	23	4017166296631	



KÄSEBEIL FORMAGGIO

Edelstahl satiniert, Griff aus Eichenholz
CHEESE HATCHET FORMAGGIO. Stainless steel satin finish, oak wood handle

Art.-Nr.	Breite cm	Länge cm	EAN	
296648	4,5	23	4017166296648	



KÄSESCHNEIDER FORMAGGIO

Edelstahl satiniert, Griff aus Eichenholz, Schnittstärke 2 und 3 mm
CHEESE SLICER FORMAGGIO. Stainless steel satin finish, oak wood handle, cutting width 2 and 3 mm

Art.-Nr.	Länge cm	EAN	
296655	29,5	4017166296655	
296709	Ersatzdraht / Replacement wire	4017166296709	

KÄSEREIBE DELUXE FORMAGGIO

Gehäuse und Reibe Edelstahl satiniert

CHEESE GRATER DELUXE FORMAGGIO. Stainless steel satin finish

Art.-Nr.	Größe cm	EAN	
190717	5,5 x 10 x 15	4017166190717	



KÄSEREIBE GUSTO FORMAGGIO

Edelstahl poliert

CHEESE GRATER GUSTO FORMAGGIO. Stainless steel mirror polished

Art.-Nr.	Größe cm	EAN	
293302	15 x 9 x 8	4017166293302	



KÄSE-PARTY RACLETTE FORMAGGIO

Metall schwarz lackiert, Griffe aus Holz, inkl. 2 antihaffbeschichteten Pfännchen, 2 Schabern und 2 Teelichtern

CHEESE PARTY RACLETTE FORMAGGIO Lacquered black metal, wooden handles, incl. 2 non-stick coated pans, 2 scrapers, 2 tealights

Art.-Nr.	Größe cm	EAN	
174007	17	4017166174007	



NUSSKNACKER KNACKI

Metall hochglanzlackiert, geeignet für verschiedene Arten von Nüssen, auch ideal zum Öffnen von Schraubverschlüssen und Sekt-/oder Champagnerflaschen

NUT CRACKER KNACKI. Lacquered metal high glossy, suitable for different types of nuts, also perfect to open bottles with screw caps and sparkling wine and champagne bottles



Art.-Nr.	Länge cm	EAN
201123**	18,5	4017166201123

** Lieferbar sortiert 15 Stück im Display: 9 x silber / 3 x rot / 3 x schwarz
Available assorted 15 pieces in display: 9 x silver / 3 x red / 3 x black

NUSSKNACKER KNACKI COLORE

Metall hochglanzlackiert, geeignet für verschiedene Arten von Nüssen, auch ideal zum Öffnen von Schraubverschlüssen und Sekt-/oder Champagnerflaschen

NUT CRACKER KNACKI COLORE. High glossy lacquered metal, suitable for different types of nuts, also perfect to open bottles with screw caps and sparkling wine or champagne bottles



Art.-Nr.	Länge cm	EAN
201178**	18,5	4017166201178

** Lieferbar sortiert 15 Stück im Display: 6 x schwarz / 6 x rot / 3 x grün
Available assorted 15 pieces in display: 6 x black / 6 x red / 3 x black

NUSSKNACKER KNACKI EXKLUSIV

Metall glänzend verchromt / rutschfeste Griffe mit Gummieinlage, geeignet für verschiedene Arten von Nüssen, auch ideal zum Öffnen von Schraubverschlüssen und Sekt-/oder Champagnerflaschen

NUT CRACKER KNACKI EXKLUSIV. Chromed metal high glossy / non-slip handles with rubber insert, suitable for different types of nuts, also perfect to open bottles with screw caps and sparkling wine or champagne bottles



Art.-Nr.	Länge cm	EAN	
162004	18,5	4017166162004	

NUSSKNACKER NOCE

Metall hochglanzverchromt / rutschfeste, gummierte Griffe, geeignet für verschiedene Arten von Nüssen

NUT CRACKER NOCE. Chromed metal high glossy / non-slip handles covered with rubber, suitable for different types of nuts

Art.-Nr.	Länge cm	EAN	
293234	16	4017166293234	



NUSSKNACKER TRIPLO

Metall hochglanzverchromt

NUT CRACKER TRIPLO. Chromed metal high glossy

Art.-Nr.	Länge cm	EAN	
293326	17,5	4017166293326	



NUSSKNACKER CLASSIC

Metall matt verchromt

NUT CRACKER CLASSIC. Chromed metal satin finish

Art.-Nr.	Länge cm	EAN	
293081	18,5	4017166293081	





EIERLÖFFEL

Echtes Seepferlmutter, einzeln in Handarbeit gefertigt - jeder Löffel ist ein Unikat
EGG SPOON. Nacre, individually handcrafted - each spoon is unique

Art.-Nr.	Länge cm	EAN
331103	11,5	4017166331103



EIERBECHER

Feuerfestes Hartporzellan, weiß, bei ca. 1.300°C gebrannt
EGG CUP. Fire-proof hard porcelain, white, burnt at approx. 1.300°C

Art.-Nr.	Ø cm	EAN
105209**	10,5	4017166105209

ohne Löffel/without spoon

** Bei Abnahme von 36 Stück Lieferung im Verkaufsdisplay
When ordering 36 pieces delivery in display package

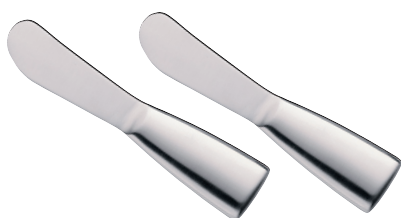

BUTTERMESSER

Edelstahl satiniert, 2 Stück im Set
BUTTER KNIFE. Stainless steel satin finish, set of 2 pieces

Art.-Nr.	Größe cm	EAN
299045	17	4017166299045



BUTTERDOSE

Hochwertiger Kunststoff, für ½ Pfund Butter (250 g)
BUTTER DISH. high-quality plastics, for ½ lb butter (250 g)

Art.-Nr.	Höhe cm	EAN
150186	18,5 x 13 x 5,5	4017166150186



KÜHLSCHRANK-BUTTERDOSE

Edelstahl poliert, für ½ Pfund Butter (250 g), passend für das Butterfach im Kühlschrank
BUTTER DISH. Stainless steel mirror polished, for ½ lb butter (250 g), fits into the butter compartment in the refrigerator

Art.-Nr.	Größe cm	EAN
260724	16 x 10 x 4	4017166260724

HONIGPORTIONIERER

Edelstahl poliert
HONEY SERVER. Stainless steel mirror polished



Art.-Nr.	Länge cm	EAN	
540086	17	4017166540086	



OBSTKORB GIRO

Metall verchromt
FRUIT BASKET GIRO. Chromed metal

Art.-Nr.	Ø	Höhe cm	EAN
305227	24	14	4017166305227



OBSTKORB ONDA

Metall verchromt
FRUIT BASKET ONDA. Chromed metal

Art.-Nr.	Größe cm	EAN
305234	30 x 30 x 10	4017166305234



VORRATSDOSE

Acryl, Deckel transparent, stapelbar
CANISTER. Acrylic, with transparent lid, stackable

Art.-Nr.	Inhalt	Höhe cm	EAN
152500	800 ml	14	4017166152500
152517	1,3 L	18	4017166152517
152524	1,6 L	22	4017166152524



BESTECKKASTEN

Gummibaumholz aus Plantagenanbau
CUTLERY ORGANIZER. Rubber wood from plantation cultivation

Art.-Nr.	Größe cm	EAN
410006	30 x 35 x 7	4017166410006
410013	34 x 43 x 7	4017166410013



ZAHNSTOCHERSPENDER

Edelstahl satiniert, mit rutschfestem Boden, inkl. 25 Zahnstochern
 TOOTHPICK DISPENSER. Stainless steel satin finish, with non-slip bottom,
 incl. 25 toothpicks

Art.-Nr.	Ø	Höhe cm	EAN
308198	5,5	10	4017166308198



SERVIETTENRINGE

Edelstahl satiniert, quadratisch, 4 Stück im Set
 NAPKIN RINGS. Stainless steel satin finish, square, set of 4 pcs.

Art.-Nr.	Größe cm	EAN
330328	4,5 x 4,5 x 3	4017166330328



SERVIETTENHALTER

Edelstahl satiniert
 NAPKIN HOLDER. Stainless steel satin finish

Art.-Nr.	Größe cm	EAN
500073	15 x 3 x 8	4017166500073





SPEISEGLAS MIT DECKEL

Hitzebeständiges Borosilikatglas, doppelwandig, inklusive Deckel, stapelbar mit aufgelegtem Deckel, Deckel auch als Untersetzer verwendbar, ideal für heiße oder kalte Vorspeisen, Beilagen oder Desserts, 2 Stück im Set

FOOD GLASS. Heat resistant borosilicate glass, double wall, incl. lid, stackable when the lid is placed on the glass, lid also usable as a trivet, ideal for hot or cold appetizers, side dishes or desserts, set of 2 pieces

Art.-Nr.	Inhalt	Ø	Höhe cm	EAN	
292701	80 ml	5,5	7	4017166292701	



SPEISEGLAS MIT DECKEL

Hitzebeständiges Borosilikatglas, doppelwandig, inklusive Deckel, stapelbar mit aufgelegtem Deckel, Deckel auch als Untersetzer verwendbar, ideal für heiße oder kalte Vorspeisen, Beilagen oder Desserts, 2 Stück im Set

FOOD GLASS. Heat resistant borosilicate glass, double wall, incl. lid, stackable when the lid is placed on the glass, lid also usable as a trivet, ideal for hot or cold appetizers, side dishes or desserts, set of 2 pieces

Art.-Nr.	Inhalt	Ø	Höhe cm	EAN	
292718	250 ml	8	9	4017166292718	



SPEISEGLAS MIT DECKEL

Hitzebeständiges Borosilikatglas, doppelwandig, inklusive Deckel, stapelbar mit aufgelegtem Deckel, Deckel auch als Untersetzer verwendbar, ideal für heiße oder kalte Vorspeisen, Beilagen oder Desserts, 2 Stück im Set

FOOD GLASS. Heat resistant borosilicate glass, double wall, incl. lid, stackable when the lid is placed on the glass, lid also usable as a trivet, ideal for hot or cold appetizers, side dishes or desserts, set of 2 pieces

Art.-Nr.	Inhalt	Ø	Höhe cm	EAN	
292725	300 ml	8	13	4017166292725	





TISCHKEHRER

Edelstahl satiniert / hochwertiger Kunststoff, mit rotierenden Borsten und abnehmbarem Deckel

TABLE TOP CLEANER. Stainless steel satin finish / high-quality plastics, with rotating brushes and detachable lid

Art.-Nr.	Größe cm	EAN
305005	16 x 9 x 3,5	4017166305005

MINI-TISCHSAUGER MAUS

Kunststoff matt verchromt / hochwertiger Kunststoff, inkl. 2 Batterien Typ 1,5V (AA)

MINI TABLE CLEANER MAUS. Satin chromed plastics / high-quality plastics, incl. 2 batteries type 1,5V (AA)



Art.-Nr.	Größe cm	EAN
305401**	10 x 8,5 x 7	4017166305401

** Bei Abnahme von 12 Stück Lieferung im farbigen Verkaufsdisplay
When ordering 12 pieces delivery in coloured display package



TISCHABFALLEIMER SWING

Edelstahl poliert/satiniert

TABLE WASTE BIN SWING. Stainless steel satin finish/mirror polished

Art.-Nr.	Ø	Höhe cm	EAN
300857	12,5	17	4017166300857



TISCHKLINGEL

Metall verchromt

TABLE BELL. Chromed metal

Art.-Nr.	Ø	Höhe cm	EAN
202472	8,5	6	4017166202472



TIMER CLASSICO

Kunststoff hochglanzverchromt, 60 Minuten
 TIMER CLASSICO. High glossy chromed plastics, 60 minutes

Art.-Nr.	Ø	Höhe cm	EAN	
294682	6,5	10,5	4017166294682	



TIMER CUBE

Edelstahl satiniert, mit Magnet an der Rückseite, 60 Min.
 TIMER CUBE. Stainless steel satin finish, with magnet on the reverse side, 60 minutes

Art.-Nr.	Größe cm	EAN	
294538	7 x 7 x 5	4017166294538	



TIMER PISA

Edelstahl satiniert, 60 Minuten
 TIMER PISA. Stainless steel satin finish, 60 minutes

Art.-Nr.		Ø	Höhe cm	EAN	
294866	rot/red	6	5	4017166294866	
294873	schwarz/black	6	5	4017166294873	



TIMER PURE

Edelstahl satiniert, mit Magnet an der Rückseite, 60 Minuten
 TIMER PURE. Stainless steel satin finish, with magnet on the reverse side, 60 minutes

Art.-Nr.	Ø	Höhe cm	EAN	
294668	6	3,5	4017166294668	
294675	8	3	4017166294675	



SANDUHR DREI-ZEIT

Edelstahl satiniert, Laufzeit ca. 3, 4, 5 Minuten
 HOUR GLASS DREI-ZEIT. Stainless steel satin finish, approx. 3, 4, 5 minutes

Art.-Nr.	Größe cm	EAN	
201406	9 x 3 x 8	4017166201406	



cilio trifft den Geist der Zeit.

Ansprechende Optik und durchdachte Funktionalität machen die Produkte zu zeitgemäßen Helfern, die nicht nur ihren Zweck erfüllen, sondern auch optisch eine gute Figur machen. Die ultimativen Basics wie Toaster oder Wasserkocher sollten in keinem Haushalt fehlen. Frühstücksmuffel lassen sich mit einem Smoothie aus Milch, frischen Früchten und Haferflocken locken und auch für unterwegs ist ein gesunder Drink die ideale Stärkung.

Das Highlight auf jeder Party ist ein Schokobrunnen, der nicht nur Kinderherzen höher schlagen lässt. Als Variante mit Currysauce und Würstchen, oder mit Käsesauce, Brot & Co. lassen sich ganz sicher auch alle Erwachsenen begeistern.

cilio meets the spirit of the time

Appealing looks and sophisticated functionality turn the products into contemporary helpers that not only fulfill their purpose, but are pleasing to the eyes as well. The ultimate basics like toaster or water kettle should not be missing in any household. Who doesn't like breakfast can be tempted with a smoothie made from milk, fresh fruits and oatmeal, and a healthy drink is also ideal on the go.

The highlight on every party is the chocolate fountain which does not only make children's hearts beat faster. As a version with curry sauce and sausages or with cheese sauce, bread & Co. all adults will surely be inspired as well.



SCHOKOLADENFONDUE

Feuerfestes Hartporzellan, weiß, bei ca. 1.300°C gebrannt, inkl. Fonduepotf, Rechaud, 4 Fonduegabeln, 1 Teelicht, Inhalt: 350 ml

CHOCOLATE FONDUE. Fire-proof hard porcelain, white, burnt at approx. 1.300°C, incl. fondue pot, warmer, 4 fondue forks, 1 tealight, capacity: 350 ml

Art.-Nr.		Ø	Höhe cm	EAN	
104417	6-teilig/6 pieces	12	15,5	4017166104417	



SCHOKOLADENFONDUE-SET

Feuerfestes Hartporzellan, weiß, bei ca. 1300°C gebrannt, Set bestehend aus Fonduepotf, Rechaud, 4 Schälchen, 4 Fonduegabeln, 1 Teelicht, Inhalt: 350 ml

CHOCOLATE FONDUE SET. Fire-proof hard porcelain, white, burnt at approx. 1.300°C, set consists of fondue pot, warmer, 4 bowls, 4 fondue forks, 1 tealight, capacity: 350 ml

Art.-Nr.		Ø	Höhe cm	EAN	
107548	10-teilig/10 pieces	12	15,5	4017166107548	



SCHOKOLADENBRUNNEN HAITI

ELEKTRISCH

Gehäuse aus hochwertigem schwarzem Kunststoff / Auffangschale und Turm Edelstahl satiniert, Ein-/Ausschalter mit Kontrollleuchte, funktioniert ab einer Menge von ca. 400 g Schokolade, Fassungsvermögen der Auffangschale: 300 ml, auch ideal mit flüssigem Käse oder Currysauce

CHOCOLATE FOUNTAIN HAITI. Housing made of high-quality black plastics / bowl and tower made of stainless steel satin finish, on/off switch with control light, usable from a quantity of 400 g chocolate, capacity of bowl 300 ml, also perfect for liquid cheese or curry sauce

Art.-Nr.	Inhalt	Ø	Höhe cm	EAN	
490121	300 ml	15,5	23	4017166490121	

230 V | 50 Hz | 32 W



SCHOKOLADENBRUNNEN PERU

ELEKTRISCH

Edelstahl satiniert, mit verstellbaren Füßen, Ein-/Ausschalter mit Kontrollleuchte, funktioniert ab einer Menge von ca. 600 g Schokolade, Fassungsvermögen der Auffangschale: 450 ml, auch ideal mit flüssigem Käse oder Currysauce

CHOCOLATE FOUNTAIN PERU. Stainless steel satin finish, on/off switch with control light, usable from a quantity of 600 g chocolate, capacity of bowl 300 ml, also perfect for liquid cheese or curry sauce

Art.-Nr.	Inhalt	Ø	Höhe cm	EAN	
490060	450 ml	19	33	4017166490060	

230 V | 50 Hz | 85 W



WASSERKOCHER RETRO

Edelstahl satiniert oder lackiert, kabelloser 360° Zentralkontakt, automatische Abschaltfunktion, Ein-/Ausschalter mit Kontrollleuchte, Skala zum Abmessen des Wasserstandes, herausnehmbarer Kalkfilter, Sicherheitsverschluss. Inhalt: 1,7 L

WATER KETTLE RETRO. Stainless steel satin finish or lacquered, cordless central contact 360°, automatic switch-off function, on/off switch with control light, scale for measuring the water level, removable limescale catcher, safety lock. Capacity: 1.7 L

Art.-Nr.		Ø	Höhe cm	EAN	
491678	Edelstahl/stainless steel	15	24,5	4017166491678	
491609	rot/red	15	24,5	4017166491609	
491616	schwarz/black	15	24,5	4017166491616	
491623	creme/off-white	15	24,5	4017166491623	

220 – 240 V | 50 / 60 Hz | 2000 – 2400 W



Produkt in Geschenkverpackung | Product in giftbox = 

TOASTER RETRO

Edelstahl satiniert oder lackiert, mit Brötchenaufsatz und Krümelschublade, Bagel-funktion (einseitiges Bräunen), Unterbrechertaste, Auftaufunktion

TOASTER RETRO. Stainless steel satin finish or lacquered, with warming rack and crumb tray, bagel function for one side toasting, stop button, defrost function

Art.-Nr.		Größe cm	EAN	
491685	Edelstahl/stainless steel	29,5 x 19,5 x 18,5	4017166491685	
491630	rot/red	29,5 x 19,5 x 18,5	4017166491630	
491647	schwarz/black	29,5 x 19,5 x 18,5	4017166491647	
491654	creme/off-white	29,5 x 19,5 x 18,5	4017166491654	

220 – 240 V | 50 Hz | 850 – 1500 W



EIERKOCHER RETRO

Edelstahl lackiert, für bis zu 7 Eier, Ein-/Ausschalter mit Kontrollleuchte, Abschalt-automatik mit akustischem Signal, inkl. Messbecher mit integriertem Ei-Picker

EGG BOILER RETRO. Stainless steel lacquered, for up to 7 eggs, on/off switch with control lamp, automatic switch off function with acoustic signal, incl. measuring jug with integrated egg pricker

Art.-Nr.		Größe cm	EAN	
492415	rot/red	21 x 21 x 17	4017166492415	
492408	schwarz/black	21 x 21 x 17	4017166492408	
492422	creme/off-white	21 x 21 x 17	4017166492422	

220 – 240 V | 50 Hz | 320 – 380 W





SMOOTHIE MAKER

Edelstahl satiniert, 22.000 Umdrehungen (+/- 15%), wahlweise Intervall- oder Permanent-Betrieb, rutschfeste FüÙe, mit 4-flügeligem Edelstahlmesser und 2 Mix-bechern aus BPA-freiem Kunststoff (Inhalt 570 ml) mit extra großer Einfüllöffnung, inkl. 2 tropf- und auslaufsicheren Trinkverschlüssen, passende Flasche mit Deckel separat erhältlich

SMOOTHIE MAKER. Stainless steel satin finish, 22.000 rotations per minute (+/- 15 %), optional interval or continuous operation, non-slip feet, with 4-bladed stainless steel knife and 2 mixing containers made of BPA free plastics (capacity: 570 ml) with large opening, incl. 2 drip and leak proof drinking lids, suitable mixing container separately available

Art.-Nr.	Ø	Höhe cm	EAN	
491401	13	35,5	4017166491401	
491449	Flasche/bottle		4017166491449	



220 – 240 V | 50/60 Hz | 300 W

SAFTPRESSE PORTOFINO

Edelstahl satiniert, mit 4 SaugfüÙen, inkl. 2 Presskegeln für verschieden große Zitrus-früchte, Saftbehälter mit AusgieÙer und praktischem Nachtropfschutz

JUICER PORTOFINO. Stainless steel satin finish, with 4 suction feet, incl. 2 press cones for differently sized citrus fruits, juice container with spout and useful anti-drip function

Art.-Nr.	Ø	Höhe cm	EAN	
491036	16,5	27,5	4017166491036	



220 – 240 V | 50/60 Hz | 300 W

cilio

BAR UND WEIN



Der Granatapfel

The pomegranate

Unergründlich, rätselhaft und von heilender Wirkung: Neben Dattel, Feige, Olive und Traube gilt der Granatapfel nicht nur als eine der ältesten Kulturfrüchte der Menschheit, sondern steht auch von jeher als Symbol für Fruchtbarkeit, Liebe und ein langes Leben.

Aus dem Persephone-Mythos des antiken Griechenlands, über das alte Rom und den Totenkult der alten Ägypter fand er seinen Weg in die modernen Weltreligionen. Selbst in Shakespeares *Romeo & Julia* sitzt die Nachtigall, die eigentlich eine Lerche ist, in einem Granatapfelbaum. Die Bäume mit ihren leuchtend roten Blüten haben ebenfalls ihren festen Platz in der Orangerie von Schloss Sanssouci in Potsdam.

Heute wird der Granatapfelsaft, der ausschließlich aus den 613 leuchtend-roten Kernen gewonnen wird, von Barkeepern als schmackhafte Zutat von Cocktails geschätzt und findet sich als originelle Geschmacksnuance in den Speisekarten von Szenorestaurants.

Profound, enigmatic and said to possess healing properties: Besides dates, figs, olives and grapes, the pomegranate is not only one of the oldest cultivated fruits known to mankind, but has also long been a symbol of fertility, love and longevity.

From the Ancient Greek myth of Persephone, via Ancient Rome and the Ancient Egyptian cult of the dead, it found its way into the modern world religions. Even in Shakespeare's *Romeo & Juliet* the nightingale, which is actually a lark, is perched in a pomegranate tree. With their brilliant red blossoms, the trees also have a permanent place in the orangery of Sanssouci Palace in Potsdam.

Today pomegranate juice, which is pressed entirely from the 613 brilliant red seeds, is valued by barkeepers as a tasty ingredient in cocktails and provides an original nuance of flavour in the menus of scene restaurants.

TIPP

Die Granatäpfel müssen reif sein!

Machen Sie den Test: Ein reifer Granatapfel sollte nicht perfekt rund sein und sich für seine Größe schwer anfühlen, denn das bedeutet, dass die Kerne sehr viel Saft enthalten. Die Schale sollte gelblich-rot bis tiefrot, lederähnlich und straff sein, und beim Klopfen sollte ein metallischer Ton entstehen – und wenn man den Granatapfel leicht drückt und er dann nachgibt, heißt das, dass die saftigen Kernchen im Fruchttinneren zerplatzen – reif!

Sollten die Fruchthälften nicht ganz ausgepresst sein, legen Sie diese etwas schräg auf den Presskegel und wiederholen Sie den Pressvorgang.

TIP

The pomegranates must be ripe!

Make the test: a ripe pomegranate should not be perfectly round and feel rather heavy in relation to its size, as this means that the kernels contain a lot of juice. The peel should be yellowish-red to deep-red, leather-like and taut, and a metallic tone should be heard when tapping on the skin – and if the pomegranate buckles when you slightly press the skin, that means that the juicy kernels inside the fruit burst – ripe!

If the fruit halves are not completely squeezed, place them a little diagonally on the press cone and repeat the procedure.





PROFI-GRANATAPFELPRESSE LIVORNO

Multi-Funktionssaftpresse für Granatäpfel und alle Zitrusfrüchte

Stabile Profi-Qualität aus Zink-Druckguss, hochglanzlackiert, Trichter und Presskegel aus Edelstahl, Saugfüße für sicheren Halt, leichte Handhabung durch effektive Hebelwirkung

Gewicht: 6,5 kg / Höhe geöffnet: 79 cm

PROFESSIONAL POMEGRANATE JUICER LIVORNO.

Multifunctional juicer for pomegranates and all citrus fruits

Sturdy professional quality made of die cast zinc, lacquered high glossy, funnel and cone made of stainless steel, suction feet for a secure stand, easy handling thanks to the effective lever action

weight 6,5 kg/ height opened: 79 cm

Art.-Nr.		Größe cm	EAN	
203349	schwarz/black	18 x 25 x 48	4017166203349	
203295	rot/red	18 x 25 x 48	4017166203295	



Profi-Saftpressen

Die Profi-Saftpressen sind nicht nur ein Design-Highlight in jeder Küche, sondern überzeugen auch durch perfekte Funktionalität und Qualität.

Die mechanische Kraftübertragung basiert auf dem alten physikalischen Gesetz der Hebelwirkung. Der lange Griff mit der ausgefeilten Übersetzung sorgt für leichtes Pressen ohne großen Kraftaufwand.

Trichter und Presskegel sind aus rostfreiem Edelstahl gefertigt, leicht zu entnehmen und spülmaschinenfest.

Die schwere Ausführung der Profi-Saftpressen in Verbindung mit den Saugfüßen gewährleisten einen sicheren Stand und somit angenehmes Arbeiten.

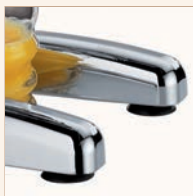

Juicer for all citrus fruits

The professional juice press is not only a design highlight in your kitchen, it also combines convenience with perfect functionality and quality.

The mechanical power transmission is based on the old physical law of lever action. The long handle makes it easy to press down with a lot of force using very little effort.

The funnel and cone are made of stainless steel, easy to remove and dishwasher safe.

The heavy construction of the juice press, combined with suction feet on the base, ensure a safe stand and easy handling.

Tipp

Für eine möglichst hohe Saftausbeute ist die die Qualität der Früchte entscheidend. Wählen Sie möglichst frisch gepflückte Früchte, die sich schwer anfühlen.

Rollen Sie zudem die Früchte vor dem Pressen einige Mal auf einer harten Unterlage hin und her. Hierdurch platzen die Zellwände, so dass Sie mehr Saft erhalten. Alternativ können die Früchte auch kurz in heißes Wasser gelegt oder für ca. 10 Sekunden in der Mikrowelle erwärmt werden.

So werden sie weicher und können noch leichter gepresst werden.

Tip

For the highest possible juice yield, the quality of the fruits is essential. Choose freshly picked fruits that feel as heavy as possible.

Roll the fruit back and forth a few times on a hard surface before pressing. This will burst the cell walls, giving you more juice. Alternatively, the fruits can also be placed briefly in hot water or heated for about 10 seconds in the microwave. This makes them softer and even easier to squeeze.





PROFI-SAFTPRESSE AMALFI

Saftpresse für alle Zitrusfrüchte.

Stabile Profi-Qualität aus Zink-Druckguss, hochglanzlackiert, Trichter und Presskegel aus Edelstahl, Saugfüße für sicheren Halt, leichte Handhabung durch effektive Hebelwirkung

Gewicht: 4,9 kg / Höhe geöffnet: 72 cm

PROFESSIONAL JUICER AMALFI.

Juicer for all citrus fruits.

Sturdy professional quality made of die cast zinc, high glossy lacquered, funnel and cone made of stainless steel, suction feet for a secure stand, easy handling thanks to the effective lever action

weight 4,9 kg/ height opened: 72 cm

Art.-Nr.		Größe cm	EAN	
309164	chrom/chromed	18 x 23 x 43	4017166309164	





PROFI-SAFTPRESSE AMALFI

Saftpresse für alle Zitrusfrüchte. Stabile Profi-Qualität aus Zink-Druckguss, hochglanzlackiert, Trichter und Presskegel aus Edelstahl, Saugfüße für sicheren Halt, leichte Handhabung durch effektive Hebelwirkung
Gewicht: 4,9 kg / Höhe geöffnet: 72 cm

PROFESSIONAL JUICER AMALFI. Juicer for all citrus fruits. Sturdy professional quality made of die cast zinc, high glossy lacquered, funnel and cone made of stainless steel, suction feet for a secure stand, easy handling thanks to the effective lever action. Weight 4,9 kg/ height opened: 72 cm

Art.-Nr.		Größe cm	EAN 
309140	schwarz/black	18 x 23 x 43	4017166309140
309133	silbergrau/silver grey	18 x 23 x 43	4017166309133
309089	crème/off white	18 x 23 x 43	4017166309089
309041	cool grey	18 x 23 x 43	4017166309041
309058	taupe	18 x 23 x 43	4017166309058



PROFI-SAFTPRESSE AMALFI

Saftpresse für alle Zitrusfrüchte. Stabile Profi-Qualität aus Zink-Druckguss, hochglanzlackiert, Trichter und Presskegel aus Edelstahl, Saugfüße für sicheren Halt, leichte Handhabung durch effektive Hebelwirkung
Gewicht: 4,9 kg / Höhe geöffnet: 72 cm

PROFESSIONAL JUICER AMALFI. Juicer for all citrus fruits. Sturdy professional quality made of die cast zinc, high glossy lacquered, funnel and cone made of stainless steel, suction feet for a secure stand, easy handling thanks to the effective lever action. Weight 4,9 kg/ height opened: 72 cm

Art.-Nr.		Größe cm	EAN 
309126	orange	18 x 23 x 43	4017166309126
309157	rot/red	18 x 23 x 43	4017166309157
309454	kupfer/copper	18 x 22 x 43	4017166309454
309065	ocean blue	18 x 23 x 43	4017166309065
309072	berry	18 x 23 x 43	4017166309072

Produkt in Geschenkverpackung | Product in giftbox = 

WASSERKARAFFE VETRO

Glas / Edelstahl satiniert, tropffreier Deckel mit 360° Ausgießfunktion, automatisches Öffnen und Schließen, Deckelkonstruktion verhindert das Herausfallen von Zutaten wie Eiswürfeln oder Fruchtstücken, passend für das Getränkefach in Standard-Kühlschränken

WATER CARAFE VETRO. Glass / stainless steel satin finish, drip-free lid with 360° pouring function, automatic opening and closing, lid construction prevents ingredients like ice cubes and pieces of fruits from falling out, suitable for the beverage compartment in standard refrigerator's doors



Art.-Nr.	Inhalt	Ø	Höhe cm	EAN 
291209	750 ml	10	29	4017166291209



cilio



Salute!

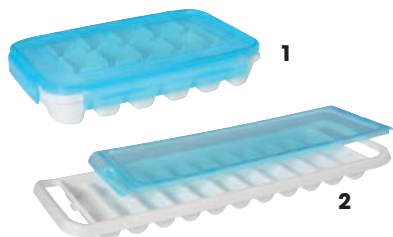

EISWÜRFELFORM

Hochwertiger Kunststoff, BPA-frei, mit auslaufsicherem Deckel
ICE CUBE TRAY. High-quality plastics, BPA free, with leak proof lid

Art.-Nr.			Größe cm	EAN
150803	1 CUBES	für 18	21,5 x 14,5 x 4	4017166150803
150810	2 STICKS	für 11	32,5 x 12,5 x 2,5	4017166150810



EISWÜRFELFORM BLOCKS

Silikon, mit Deckel, temperaturbeständig von -30°C bis +230°C
ICE CUBE TRAY BLOCKS. Silicone, with lid, temperature resistant from -30°C to +230°C

Art.-Nr.			Größe cm	EAN
150834	1 für 6		17 x 12 x 5	4017166150834
150841	2 für 15		19,5 x 13,5 x 4	4017166150841



KÜHLWÜRFEL STEEL

Edelstahl poliert, mit Kühlflüssigkeit innen, in praktischer Aufbewahrungsdose, 4 Stück im Set

COOLING CUBES STEEL. Stainless steel mirror polished, with cooling liquid inside, in useful storage box, set of 4 pieces

Art.-Nr.			Größe cm	EAN
150704			2,5 x 2,5 x 2,5	4017166150704



KÜHLSTEINE COOL ROCKS

Granit, inkl. Tasche zur Aufbewahrung, 9 Stück im Set

COOLING STONES COOL ROCKS. Granite, incl. bag for storage, set of 9 pieces

Art.-Nr.			Größe cm	EAN
150711			2 x 2 x 2	4017166150711



COCKTAILLÖFFEL

Edelstahl satiniert, mit Trinkhalm

COCKTAIL SPOON WITH STRAW. Stainless steel satin finish

Art.-Nr.			Länge cm	EAN
470222	1 mit Trinkhalm		19,5	4017166470222

Edelstahl satiniert, mit Stößel. Gedrehter Stiel für mehr Stabilität

COCKTAIL SPOON WITH PESTLE. Stainless steel satin finish, with twisted stem

Art.-Nr.			Länge cm	EAN
470253	2 mit Stößel		25	4017166470253

BECHER MOSCOW MULE

Innen Edelstahl / außen hochglanzverkupfert

MUG MOSCOW MULE. Inside stainless steel / outside high glossy coppered

Art.-Nr.	Inhalt	Ø	Höhe cm	EAN
200409	500 ml	9,5	9,5	4017166200409



BECHER MOSCOW MULE

Innen Edelstahl / außen verkupfert, Hammerschlag

MUG MOSCOW MULE. Inside stainless steel / outside coppered, hammered finish

Art.-Nr.	Inhalt	Ø	Höhe cm	EAN
200416	500 ml	9,5	9,5	4017166200416



MOSCOW MULE

Den Becher zur Hälfte mit Eiswürfeln füllen, 3 cl Wodka und 1 cl Limettensaft hinzugeben und mit 15 cl Ginger Beer auffüllen. Mit einer Limettenscheibe garniert servieren.

MOSCOW MULE

Fill the cup halfway with ice cubes, add 3 cl of vodka and 1 cl lime juice and fill up with Ginger Beer. Serve garnished with a slice of lime.





BARSIEB

Edelstahl poliert, mit abnehmbarer Spiralfeder
BAR STRAINER. Stainless steel mirror polished, with removable spiral coil

Art.-Nr.	Länge cm	EAN
202250	17	4017166202250

BARMASS

Edelstahl satiniert
JIGGER. Stainless steel satin finish



Art.-Nr.	Inhalt	Höhe cm	EAN
200232	20/30 ml	8	4017166200232

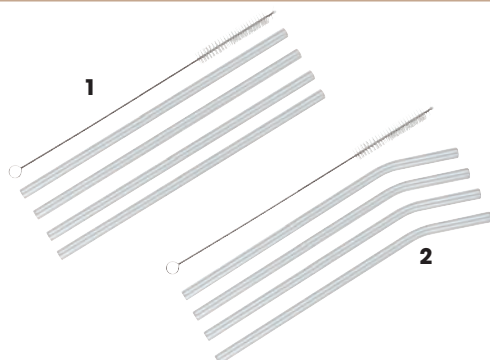

TRINKHALME VETRO

Borosilikatglas, hitzebeständig, inkl. Reinigungsbürste, 4 Stück im Set
DRINKING STRAWS VETRO. Borosilicate glass, heat resistant, incl. cleaning brush, set of 4 pieces

Art.-Nr.	Inhalt	Länge cm	EAN
150612	1 gerade / straight	23	4017166150612

Art.-Nr.	Inhalt	Länge cm	EAN
150629	2 gebogen / curved	23	4017166150629



TRINKHALME STEEL

Edelstahl, poliert, mit Knick, inkl. Reinigungsbürste, 6 Stück im Set
DRINKING STRAWS STEEL. Stainless steel, mirror polished, with kink, incl. cleaning brush, set of 6 pieces

Art.-Nr.	Länge cm	EAN
150605	22,5	4017166150605

CAIPIRINHA-STÖSSEL

Gummibaumholz aus Plantagenanbau
PESTLE FOR CAIPIRINHA. Rubber plant wood from plantation cultivation



Art.-Nr.	Länge cm	EAN
200263	18	4017166200263

COCKTAILSHAKER MIT REZEPTEN

Glas / Edelstahl poliert, Deckel mit integriertem Sieb und Verschlusskappe, 6 Rezepte auf dem Glas (Bloody Mary / Virgin Colada / Mai Tai / Whiskey Sour / Sex on the beach / Cosmopolitan)

COCKTAIL SHAKER WITH RECIPES. Glass / stainless steel mirror polished, lid with integrated sieve and cover, 6 recipes on the glass (Bloody Mary / Virgin Colada / Mai Tai / Whiskey Sour / Sex on the beach / Cosmopolitan)

Art.-Nr.	Inhalt	Ø	Höhe cm	EAN	
200300	400 ml	8	23	4017166200300	



COCKTAILSHAKER

Edelstahl satiniert, Deckel mit integriertem Sieb und Verschlusskappe

COCKTAIL SHAKER. Stainless steel satin finish, lid with integrated sieve and cover

Art.-Nr.	Inhalt	Ø	Höhe cm	EAN	
200249	500 ml	8,5	20	4017166200249	
200256	700 ml	8,5	25	4017166200256	



BOSTON SHAKER

Edelstahl poliert / Glas, extra dünnwandiger Mixbecher und stabiles Glas, abnehmbarer Dichtungsring aus Silikon

BOSTON SHAKER. Stainless steel mirror polished, extra thin mixing jug and solid glass

Art.-Nr.	Inhalt	Ø	Höhe cm	EAN	
200317	400 ml	9	29	4017166200317	



BAR-SET

Edelstahl poliert, Set bestehend aus Cocktailshaker (Inhalt: 500 ml), Cocktaillöffel, Eiszange, Barsieb und Barmaß (Inhalt: 20/30 ml)

BAR SET. Stainless steel mirror polished, set consists of: cocktail shaker (capacity: 500 ml), cocktail spoon, ice tongs, bar strainer and jigger (capacity: 20/30 ml)

Art.-Nr.	EAN	
202212	5-teilig/5 pieces	4017166202212





ZITRONENSAFT-AUSGIESSER

Edelstahl poliert, auch für Limetten geeignet
LEMON JUICE POURER. Stainless steel mirror polished, also suitable for limes

Art.-Nr.	Höhe cm	EAN	
293180	7,5	4017166293180	

AUSGIESSER MEZZO

Edelstahl poliert / Silikon, passend für Flaschenöffnungen 16 – 20 mm, mit Luftrückführung für perfektes Dosieren, geeignet für Öl, Essig oder Spirituosen, 2 Stück im Set
POURER MEZZO. Stainless steel, mirror polished, suitable for bottle openings 16 – 20 mm, with air recirculation for even pouring, perfect for oil, vinegar or spirits, set of 2 pieces



Art.-Nr.	Ø	Höhe cm	EAN	
107180	0,9	8,5	4017166107180	



ICE CRUSHER BASIC

Hochwertiger Kunststoff / Messer aus rostfreiem Stahl, mit Kurbel
ICE CRUSHER BASIC. High-quality plastics / knife made of stainless steel, with crank

Art.-Nr.	Größe cm	EAN	
202465	11,5 x 11,5 x 23	4017166202465	



TASCHENFLASCHE

Edelstahl poliert, mit Trichter
HIP FLASK. Stainless steel mirror polished, with funnel

Art.-Nr.	Inhalt	Größe cm	EAN	
304015	175 ml	9,5 x 11	4017166304015	
304008	200 ml	9,5 x 12,5	4017166304008	



GLASMARKER PARTY PEOPLE

Silikon, mit Saugnäpfen für Halt an glatten Oberflächen, 12 verschiedene Figuren im Set
GLASS MARKER PARTY PEOPLE. Silicone, with suction feet for secure hold, set of 12 different figures

Art.-Nr.	Höhe cm	EAN	
113006	2,3	4017166113006	

cilio

BAR UND WEIN





KORKENZIEHER VINUM

Metall hochglanzverchromt / hochwertiger Kunststoff, hochwertige Spirale mit spezieller Beschichtung

CORKSCREW VINUM. Chromed metal high glossy / high-quality plastics, high-quality spiral with special coating

Art.-Nr.	Größe cm	EAN	
151220	7,5 x 3 x 16	4017166151220	



FLÜGEL-KORKENZIEHER VINO

Metall hochglanzverchromt, inkl. Kapselheber

WING CORKSCREW VINO. Chromed metal high glossy, incl. bottle opener

Art.-Nr.	Größe cm	EAN	
151305	4 x 1,2 x 17,5	4017166151305	



KORKENZIEHER CHABLIS

Metall matt verchromt / hochwertiger Kunststoff, hochwertige Spirale mit spezieller Beschichtung, integrierter Folienschneider, inkl. Ersatzspirale

CORKSCREW CHABLIS. Chromed metal satin finish / high-quality plastics, high-quality spiral with special coating, integrated foil cutter, incl. replacement spiral

Art.-Nr.	Größe cm	EAN	
350135	16 x 12	4017166350135	



KORKENZIEHER VITESSE

Metall matt verchromt / hochwertiger Kunststoff, hochwertige Spirale mit spezieller Beschichtung, inkl. Folienschneider und Ersatzspirale

CORKSCREW VITESSE. Chromed metal satin finish / high-quality plastics, high-quality spiral with special coating, incl. foil cutter and replacement spiral

Art.-Nr.	Größe cm	EAN	
153002	2-teilig/2 pieces 21 x 15	4017166153002	



KORKENZIEHER LAFITE

Metall hochglanzverchromt, hochwertige Spirale mit spezieller Beschichtung, inkl. Folienschneider und Ersatzspirale

CORKSCREW LAFITE. Chromed metal high glossy, high-quality spiral with special coating, incl. foil cutter and replacement spiral

Art.-Nr.	Größe cm	EAN	
151282	2-teilig/2 pieces 19 x 13,5	4017166151282	

WEIN-SET BARDOLINO

Edelstahl poliert / hochwertiger Kunststoff, Set bestehend aus Kellnermesser mit 2-stufigem Hebel und Tropfenfänger, in Holz-Geschenkbox 14 x 9,5 x 2 cm

WINE SET BARDOLINO. Stainless steel mirror polished / high-quality plastics, set consists of waiter's knife with 2-stage lever and drip catcher, in wooden gift box 14 x 9,5 x 2 cm

Art.-Nr.		EAN
301298	2-teilig/2 pieces	4017166301298



WEIN-SET BARDOLINO

Edelstahl poliert / hochwertiger Kunststoff, Set bestehend aus Kellnermesser mit 3 Funktionen (Korkenzieher mit 2-stufigem Hebel, Kapselheber, Folienschneider), Tropfenfänger und Flaschenverschluss, in Holz-Geschenkbox 16,5 x 9 x 3 cm

WINE SET BARDOLINO. Stainless steel mirror polished / high-quality plastics, set consists of waiter's knife with 3 functions (corkscrew with 2-stage lever, bottle opener and foil cutter), drip catcher and bottle stopper, in wooden gift box 16,5 x 9 x 3 cm

Art.-Nr.		EAN
301304	3-teilig/3 pieces	4017166301304



WEIN-SET TOSCANA

Set bestehend aus Korkenzieher, Folienschneider, Tropfenfänger und Weinausgießer, in Holz-Geschenkbox 19 x 14 x 6 cm

WINE SET TOSCANA. Set consists of corkscrew, foil cutter, drip catcher and wine pourer, in wooden gift box 19 x 14 x 6 cm

Art.-Nr.		EAN
301144	4-teilig/4 pieces	4017166301144



WEIN-SET TRENTINO

Set bestehend aus Korkenzieher, Folienschneider, Flaschenverschluss und Weinthermometer, in Holz-Geschenkbox 19 x 14 x 6 cm

WINE SET TRENTINO. Set consists of corkscrew, foil cutter, bottle stopper and wine thermometer, in wooden gift box 19 x 14 x 6 cm

Art.-Nr.		EAN
301151	4-teilig/4 pieces	4017166301151





KELLNERMESSER LEGNO

Edelstahl satiniert / Holz, 3 Funktionen: Korkenzieher mit 2-stufigem Hebel, Kapselheber und Folienschneider

WAITER'S KNIFE LEGNO. Stainless steel satin finish / wood, 3 functions: corkscrew with 2-stage lever, bottle opener and foil cutter

Art.-Nr.	Länge cm	EAN
205053	12	4017166205053

KELLNERMESSER CLASSIC

Edelstahl satiniert, 3 Funktionen: Korkenzieher mit 2-stufigem Hebel, Kapselheber und Folienschneider

WAITER'S KNIFE CLASSIC. Stainless steel satin finish, 3 functions: corkscrew with 2-stage lever, bottle opener and foil cutter



Art.-Nr.	Länge cm	EAN
205060	12	4017166205060

KELLNERMESSER PUGLIA

Edelstahl poliert / hochwertiger Kunststoff, 3 Funktionen: Korkenzieher mit 2-stufigem Hebel, Kapselheber und Folienschneider

WAITER'S KNIFE PUGLIA. Stainless steel satin finish / high-quality plastics, 3 functions: corkscrew with 2-stage lever, bottle opener and foil cutter



Art.-Nr.	Länge cm	EAN
205503**	12	4017166205503

** Lieferbar sortiert 18 Stück im Display: 6 x silber / 6 x rot / 6 x schwarz
Available assorted colors 18 pieces in display: 6 x silver / 6 x red / 6 x black

FOLIENSCHNEIDER

Edelstahl satiniert / hochwertiger Kunststoff

FOIL CUTTER. Stainless steel satin finish / high-quality plastics



Art.-Nr.	Größe cm	EAN
150520	6,5 x 6	4017166150520

TROPFENFÄNGER

Edelstahl poliert, 2 Stück im Set

DRIP CATCHER. Stainless steel mirror polished, set of 2 pieces



Art.-Nr.	Ø cm	EAN
200539	4	4017166200539

WEINPUMPE MIT 2 STOPFEN

Edelstahl satiniert / hochwertiger Kunststoff, inkl. 2 Stopfen, Stopfen im praktischen 2er-Set separat erhältlich

WINE PUMP WITH 2 STOPPERS. Stainless steel / high-quality plastics, incl. 2 stoppers, stopper as useful set of 2 pieces separately available

Art.-Nr.	Höhe cm	EAN	
205015	15	4017166205015	
205022	Ersatzstopfen (2 Stk.) / replacement stoppers (2 pcs.)		4017166205022



WEINVERSCHLUSS LEVA

Edelstahl satiniert / hochwertiger Kunststoff

WINE STOPPER LEVA. Stainless steel satin finish / high-quality plastics

Art.-Nr.	Ø	Höhe cm	EAN	
300994	3,8	8,5	4017166300994	



FLASCHENVERSCHLUSS

Edelstahl satiniert, einfache Handhabung – aufsetzen, einrasten und durch Knopfdruck lösen

BOTTLE STOPPER. Stainless steel satin finish, easy handling – put on, engage and release by pushing the button

Art.-Nr.	Höhe cm	EAN	
300888	Champagner/champagne	4,5	4017166300888
300871	Wein/wine	4,5	4017166300871



CHAMPAGNERVERSCHLUSS

Edelstahl satiniert

CHAMPAGNE STOPPER. Stainless steel satin finish

Art.-Nr.	Höhe cm	EAN	
201819	5,5	4017166201819	





DropStop® VERKAUFSDISPLAY

48 Karten à 2 DropStop®

Art.-Nr.	Inhalt	Ø	Größe cm	EAN	
117004	48 Karten	7,5	15 x 10 x 42	4017166117004	



DropStop® NACHFÜLLPACK

48 Karten à 2 DropStop®

Art.-Nr.	Inhalt	Ø	EAN	
117011	48 Karten	7,5	5701036901501	



Ihr individueller Werbeträger!

Der Dropstop® ist das optimale Werbegeschenk für Ihr Unternehmen.

Ob nur einfarbig bedruckt mit Ihrem Logo, oder mit einem bunten Motiv und Ihrem Slogan versehen, gewinnen Sie eine besondere Aufmerksamkeit. Als Highlight lässt sich Ihre Auflage sogar personalisieren. All das in einer bestechenden Qualität.

Auch bei der Verpackung stehen Ihnen viele unterschiedliche Möglichkeiten zur Verfügung, die in Ihrem Design gestaltet werden können.



WEINAUSGIESSER

Hochwertiger Kunststoff, mit Dekantierfunktion, 2 Stück im Set
WINE POURER. High-quality plastics, with decanting function, set of 2 pieces

Art.-Nr.	Höhe cm	EAN	
205091	9,5	4017166205091	



DEKANTIERAUSGIESSER

Edelstahl satiniert, mit speziellem Siebeinsatz zur Belüftung des Weins
DECANTING POURER. Stainless steel satin finish, with special insert for airing the wine

Art.-Nr.	Höhe cm	EAN	
162042	8	4017166162042	



DEKANTIERTRICHTER BURGUNDER

Edelstahl poliert, inkl. Siebeinsatz und praktischem Griff
DECANTING FUNNEL BURGUNDER. Stainless steel mirror polished, incl. strainer and useful handle

Art.-Nr.	Höhe cm	EAN	
200607	16,5	4017166200607	



DEKANTER VETRO

Glas
DECANTER VETRO. Glass

Art.-Nr.	Inhalt	Ø	Höhe cm	EAN
236705	1 L	21	24	4017166236705





FLASCHENKÜHLTASCHE FROSTY

Flexibler Kunststoff mit Kühlgel, passend für Flaschen bis 9 cm Durchmesser, ideal zum Kühlhalten von vorgekühlten Flaschen, platzsparende Aufbewahrung im Gefrierschrank, wiederverwendbar

BOTTLE COOLING BAG FROSTY. Flexible plastics with cooling gel, suitable for bottles up to 9 cm diameter, ideal for keeping pre-cooled bottles, space saving storage in the freezer, reusable

Art.-Nr.	Größe cm	EAN
159004	9 x 9 x 25	4017166159004

** Lieferbar sortiert 12 Stück im Display: 8 x weiß / 4 x blau
Available assorted 12 pieces in display: 8 x white / 4 x blue

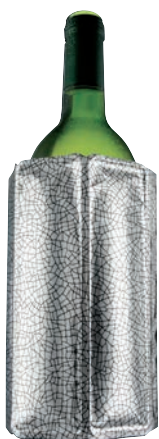

KÜHLMANSCHETTE WINE COOLER

Flexibler Kunststoff mit Aktiv-Kühlgel, passend für Flaschen von 0,7 L bis 1 L, platzsparende Aufbewahrung im Gefrierschrank, kühlt Getränke innerhalb von 5 Minuten ab, hält Getränke stundenlang kühl, wiederverwendbar

COOLING SLEEVE WINE COOLER. Flexible plastics with active cooling gel, suitable for bottles from 0,7 L to 1 L, space saving storage in the freezer, cools down beverages within 5 minutes, keeps beverages cold for several hours, reusable

Art.-Nr.	Größe cm	EAN	
113013	Ø 10 x 18	4017166113013	



WEINKÜHLER BASIC

Acryl, mit Doppelwandsystem

WINE COOLER BASIC. Acrylic, with double wall system

Art.-Nr.	Ø	Höhe cm	EAN
150513	12	23	4017166150513



WEINKÜHLER CLASSICO

Edelstahl satiniert, mit Doppelwandsystem

WINE COOLER CLASSICO. Stainless steel satin finish with double wall system

Art.-Nr.	Ø	Höhe cm	EAN	
150919	11,5	20	4017166150919	

cilio

*Mein
kleines Italien
unterwegs*

OUTDOOR



'O sole mio

Leben in und mit der Natur. Einfach mal die Seele baumeln lassen, ob romantisch zu zweit, gemütlich mit der Familie oder ausgelassen mit Freunden: mit der Outdoor-Collection von **cilio** holen Sie sich die Sonne Italiens an den heimischen Himmel.

Genießen Sie italienisches Flair wann und wo immer Sie wollen.

'O sole mio

Be at one with nature. Just set your soul free. Whether it's a romantic moment for two, a cosy time at home with the family or just relaxing with friends. With the Outdoor collection from **cilio** you bring the sunshine of Italy to the skies above you.

Enjoy Italian flair whenever and wherever you want it.



PICKNICK-KORB GARDA

4 PERSONEN

Hellbraune Weide, geflochten / alle Innen- und Außenriemen aus Kunstleder / Trageriemen aus Nylon, mit Innenfutter, großes Kühlfach

PICNIC BASKET GARDA. 4 Persons. Light brown plaited willow / all inner and outer stripes made of synthetic leather / carrying strap made of nylon, with lining, large cooling compartment

Art.-Nr.

156768

Größe cm

47 x 31 x 25

EAN

4017166156768



x4 Löffel, Messer, Gabeln
spoons, knives, forks



x4 Teller
plates



x4 Gläser
glasses



x1 Korkenzieher
corkscrew



PICKNICK-KORB COMO

4 PERSONEN

Dunkelbraune Weide, geflochten / alle Innen- und Außenriemen aus Kunstleder, mit Innenfutter, großes Kühlfach

PICNIC BASKET COMO. 4 Persons. Dark brown plaited willow / all inner and outer stripes made of synthetic leather, with lining, large cooling compartment

Art.-Nr.	Größe cm	EAN
155105	47 x 31 x 40	4017166155105

 **x4** Löffel, Messer, Gabeln
spoons, knives, forks

 **x4** Kelche
gobelets

 **x4** Teller
plates

 **x4** Servietten
napkins



PICKNICK-KORB VERBANIA

4 PERSONEN

Hellbraune Weide, geflochten / alle Innen- und Außenriemen aus Kunstleder, mit Innenfutter, separate Bestecktasche, separates Kühlfach

PICNIC BASKET VERBANIA. 4 Persons. Light brown plaited willow / all inner and outer stripes made of synthetic leather, with lining, separate cutlery bag, separate cooling compartment

Art.-Nr.	Größe cm	EAN
155709	51 x 33 x 43	4017166155709

 **x4** Löffel, Messer, Gabeln
spoons, knives, forks

 **x4** Kelche
gobelets

 **x4** Teller
plates

 **x4** Servietten
napkins



PICKNICK-KORB VARESE

4 PERSONEN

Dunkelbraune Weide, geflochten / alle Innen- und Außenriemen aus Kunstleder / Trageriemen aus Nylon, mit Innenfutter, großes Kühlfach

PICNIC BASKET VARESE. 4 Persons. Dark brown plaited willow / all inner and outer stripes made of synthetic leather / carrying strap made of nylon, with lining, large cooling compartment

Art.-Nr.	Größe cm	EAN
155259	46 x 30 x 22	4017166155259

 **x4** Löffel, Messer, Gabeln
spoons, knives, forks

 **x4** Gläser
glasses

 **x4** Teller
plates

 **x1** Korkezieher
corkscrew





PICKNICK-KORB LAVENO

4 PERSONEN

Dunkelbraune Weide, geflochten / alle Innen- und Außenriemen aus Kunstleder / Trageriemen aus Nylon, mit Innenfutter, separates Kühlfach

PICNIC BASKET LAVENO. 4 Persons. Dark brown plaited willow / all inner and outer stripes made of synthetic leather / carrying strap made of nylon, with lining, separate cooling compartment

Art.-Nr.	Größe cm	EAN
156614	46 x 31 x 26	4017166156614

 x4 Löffel, Messer, Gabeln
spoons, knives, forks

 x4 Gläser
glasses

 x4 Teller
plates

 x1 Korkezieher
corkscrew



PICKNICK-KORB PARADISO

4 PERSONEN

Blau-graue Weide, geflochten / alle Innen- und Außenriemen aus Kunstleder / Trageriemen aus Nylon, mit Innenfutter, herausnehmbare Kühltasche

PICNIC BASKET PARADISO. 4 Persons. Blue-grey plaited willow / all inner and outer stripes made of synthetic leather / carrying strap made of nylon, with lining, removable insulated bag



 x4 Löffel, Messer, Gabeln
spoons, knives, forks

 x4 Gläser
glasses

 x4 Teller
plates

 x1 Korkezieher
corkscrew



PICKNICK-KORB LENNO

4 PERSONEN

Braune Weide, geflochten / alle Innen- und Außenriemen aus Kunstleder, mit Innenfutter

PICNIC BASKET LENNO. 4 Persons. Brown plaited willow / all inner and outer stripes made of synthetic leather, with lining



Art.-Nr.	Größe cm	EAN
156720	42 x 28 x 20	4017166156720

 x4 Löffel, Messer, Gabeln
spoons, knives, forks

 x4 Gläser
glasses

 x4 Teller
plates



PICKNICK-KORB CERNOBBIO

2 PERSONEN

Hellbraune Weide, geflochten / alle Innen- und Außenriemen aus Kunstleder, mit Innenfutter, integriertes Fach für 2 Flaschen, herausnehmbare Kühltasche

PICNIC BASKET CERNOBBIO. 2 Persons. Light brown plaited willow / all inner and outer stripes made of synthetic leather, with lining, integrated compartment for 2 bottles, removable insulated bag

Art.-Nr.	Größe cm	EAN
156621	44 x 30 x 22	4017166156621



 x2 Löffel, Messer, Gabeln
spoons, knives, forks

 x2 Gläser
glasses

 x2 Teller
plates

 x1 Korkenzieher
corkscrew

PICKNICK-KORB MELANO

2 PERSONEN

Hellbraune Weide, geflochten / alle Innen- und Außenriemen aus Kunstleder, mit Innenfutter, großes Kühlfach

PICNIC BASKET MELANO. 2 Persons. Dark brown plaited willow / all inner and outer stripes made of synthetic leather, with lining, large cooling compartment

Art.-Nr.	Größe cm	EAN
156607	40 x 30 x 20	4017166156607



 x2 Löffel, Messer, Gabeln
spoons, knives, forks

 x2 Gläser
glasses

 x2 Teller
plates

 x1 Korkenzieher
corkscrew

PICKNICK-KORB STRESA

2 PERSONEN

Olivgrüne Weide, geflochten / alle Innen- und Außenriemen aus Kunstleder, mit Innenfutter, großes Kühlfach

PICNIC BASKET STRESA. 2 Persons. Olive-green plaited willow / all inner and outer stripes made of synthetic leather, with lining, large cooling compartment

Art.-Nr.	Größe cm	EAN
155716	40 x 28 x 20	4017166155716



 x2 Löffel, Messer, Gabeln
spoons, knives, forks

 x2 Gläser
glasses

 x2 Teller
plates

 x1 Korkenzieher
corkscrew



PICKNICK-KORB BELLANO

2 PERSONEN

Dunkelbraune Weide, geflochten / alle Innen- und Außenriemen aus Kunstleder, mit Innenfutter, großes Kühlfach

PICNIC BASKET BELLANO. 2 Persons. Dark brown plaited willow / all inner and outer stripes made of synthetic leather, with lining, large cooling compartment

Art.-Nr.	Größe cm	EAN
155921	40 x 28 x 20	4017166155921

 x2 Löffel, Messer, Gabeln
spoons, knives, forks

 x2 Gläser
glasses

 x2 Teller
plates

 x1 Korkezieher
corkscrew



PICKNICK-KORB RIVA

2 PERSONEN

Hellbraune Weide, geflochten / alle Innen- und Außenriemen aus Kunstleder, mit Innenfutter, großes Kühlfach

PICNIC BASKET RIVA. 2 Persons. Light brown plaited willow / all inner and outer stripes made of synthetic leather, with lining, large cooling compartment

Art.-Nr.	Größe cm	EAN
156751	45 x 31 x 25	4017166156751



 x2 Löffel, Messer, Gabeln
spoons, knives, forks

 x2 Gläser
glasses

 x2 Teller
plates



PICKNICK-KORB AROLO

2 PERSONEN

Vintage-weiße Weide, geflochten / alle Innen- und Außenriemen aus Kunstleder, mit Innenfutter

PICNIC BASKET AROLO. 2 Persons. Vintage white willow / all inner and outer stripes made of synthetic leather, with lining

Art.-Nr.	Größe cm	EAN
156645	40 x 28 x 18	4017166156645



 x2 Löffel, Messer, Gabeln
spoons, knives, forks

 x2 Tassen
mugs

 x2 Teller
plates



PICKNICK-DECKE

ROT

Polyester, weiche Oberfläche und wasserabweisende Unterseite, mit Klettverschluss und Trageriemen

PICNIC BLANKET. Red. Polyester, soft surface and water-repellent bottom, with hook-and-loop fastener and carrying strap

Art.-Nr.		Größe cm	EAN
155778	WEEKEND	145 x 130	4017166155778
156652	BEACH	200 x 200	4017166156652



PICKNICK-DECKE

BEIGE

Polyester, weiche Oberfläche und wasserabweisende Unterseite, mit Klettverschluss und Trageriemen

PICNIC BLANKET. Beige. Polyester, soft surface and water-repellent bottom, with hook-and-loop fastener and carrying strap

Art.-Nr.		Größe cm	EAN
155969	WEEKEND	145 x 130	4017166155969
156706	BEACH	200 x 200	4017166156706



PICKNICK-DECKE

BLAU

Polyester, weiche Oberfläche und wasserabweisende Unterseite, mit Klettverschluss und Trageriemen

PICNIC BLANKET. Blue. Polyester, soft surface and water-repellent bottom, with hook-and-loop fastener and carrying strap

Art.-Nr.		Größe cm	EAN
156713	WEEKEND	145 x 130	4017166155713
156676	BEACH	200 x 200	4017166156676





KÜHLTASCHEN-RUCKSACK RIVIERA

Strapazierfähiges Polyester / aufgeschäumte Folie zum Isolieren, mit 3 Kühlfächern, verstellbare Schultergurte, Tragegriff, Fronttasche mit Reißverschluss und Utensilienhalterung, 2 seitliche Netztaschen, Inhalt: 25 L 16 L 14 L

INSULATED BACKPACK RIVIERA. Heavy duty polyester / foamed insulating foil, with 3 cooling compartments, adjustable shoulder straps, carrying handle, front bag with zipper and holder for utensils, 2 mesh side pockets, capacity: 25 L 16 L 14 L

Art.-Nr.	Farbe	Größe cm	EAN
157369	schwarz-blau/black-blue	35 x 22 x 46	4017166157369



FOOD CONTAINER MONTE

Edelstahl lackiert, mit Doppelwandsystem, bruch- und auslaufsicher, Schraubverschluss, inkl. klappbarem Löffel aus Edelstahl

Lacquered stainless steel. With double wall system, break and leak proof, screw cap, incl. foldable spoon made of stainless steel



Art.-Nr.	Inhalt	Ø	Höhe cm	EAN	
545524	500 ml	9	15,5	4017166545524	
545616	750 ml	9	20	4017166545616	



FELDFLASCHE MONTE

Edelstahl lackiert, mit Doppelwandsystem, auslauf- und bruchsicher, verstellbarer Trageriemen, Schraubverschluss mit integriertem Kompass

CANTEEN FLASK MONTE. Lacquered stainless steel, with double wall system, break and leak proof, with adjustable carrying strap, screw cap with integrated compass



Art.-Nr.	Inhalt	Größe cm	EAN	
545609	700 ml	15,5 x 8 x 21	4017166545609	

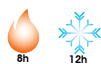



ISOLIERTASCHE DOLOMITI

Strapazierfähiges Polyester / aufgeschäumte Folie zum Isolieren, verstellbarer Tragegurt, 2 Innentaschen, zusätzliche Außentasche mit Reißverschluss

INSULATED BAG DOLOMITI. Heavy duty polyester / foamed insulating foil, adjustable carrying strap, 2 inner pockets, additional outer pocket with zipper

Art.-Nr.	Farbe	Inhalt	Größe cm	EAN
106206	silber/silver	6 Liter	21 x 12,5 x 24	4017166106206
106213	silber/silver	12 Liter	27 x 17 x 30	4017166106213



ISOLIERTASCHE DOLOMITI

Strapazierfähiges Polyester / aufgeschäumte Folie zum Isolieren, verstellbarer Tragegurt, 2 Innentaschen, zusätzliche Außentasche mit Reißverschluss

INSULATED BAG DOLOMITI. Heavy duty polyester / foamed insulating foil, adjustable carrying strap, 2 inner pockets, additional outer pocket with zipper

Art.-Nr.	Farbe	Inhalt	Größe cm	EAN
106220	rot/red	6 Liter	21 x 12,5 x 24	4017166106220
106237	rot/red	12 Liter	27 x 17 x 30	4017166106237





ISOLIERTASCHE MARE

Strapazierfähiges Polyester / aufgeschäumte Folie zum Isolieren, verstellbarer Trage-riemen, 2 Tragegriffe, 1 seitliche Außentasche, 1 seitliche Netztasche mit Reißverschluss, 1 Einstecktasche vorne

INSULATED BAG MARE. Heavy duty polyester / foamed insulating foil, adjustable carrying strap, 2 carry handles, 1 outer side pocket, 1 outer side mesh pocket with zipper, 1 insert pocket at the front

Art.-Nr.	Farbe	Inhalt	Größe cm	EAN
106381	jeansblau/blue	9 L	29 x 15 x 22	4017166106381
106398	jeansblau/blue	25 L	46 x 23 x 26	4017166106398



ISOLIERTASCHE DUNA

Strapazierfähiges Polyester / aufgeschäumte Folie zum Isolieren, verstellbarer Trage-riemen, 2 Tragegriffe, 1 Tasche mit Klettverschluss vorne

INSULATED BAG DUNA. Heavy duty polyester / foamed insulating foil, adjustable carrying strap, 2 carry handles, 1 pocket with hook-and-loop fastener at the front

Art.-Nr.	Farbe	Inhalt	Größe cm	EAN
106558	jeansblau/blue	18 L	32 x 20 x 33	4017166106558



ISOLIERTASCHE SOLE

Strapazierfähiges Polyester / aufgeschäumte Folie zum Isolieren, mit 2 Schultergurten und Reißverschluss

INSULATED BAG SOLE. Heavy duty polyester / foamed insulating foil, with 2 shoulder straps and zipper

Art.-Nr.	Farbe	Inhalt	Größe cm	EAN
106541	jeansblau/blue	10 L	43 x 16 x 34,5	4017166106541

ISOLIERTASCHE MARE

Strapazierfähiges Polyester / aufgeschäumte Folie zum Isolieren, verstellbarer Trage-riemen, 2 Tragegriffe, 1 seitliche Außentasche, 1 seitliche Netztasche mit Reißverschluss, 1 Einstecktasche vorne

INSULATED BAG MARE. Heavy duty polyester / foamed insulating foil, adjustable carrying strap, 2 carry handles, 1 outer side pocket, 1 outer side mesh pocket with zipper, 1 insert pocket at the front

Art.-Nr.	Farbe	Inhalt	Größe cm	EAN
106336	blau/blue	9 L	29 x 15 x 22	4017166106336
106367	rot/red	9 L	29 x 15 x 22	4017166106367
106350	blau/blue	25 L	46 x 23 x 26	4017166106350
106374	rot/red	25 L	46 x 23 x 26	4017166106374



ISOLIERTASCHE DUNA

Strapazierfähiges Polyester / aufgeschäumte Folie zum Isolieren, verstellbarer Trage-riemen, 2 Tragegriffe, 1 Tasche mit Klettverschluss vorne

INSULATED BAG DUNA. Heavy duty polyester / foamed insulating foil, adjustable carrying strap, 2 carry handles, 1 pocket with hook-and-loop fastener at the front

Art.-Nr.	Farbe	Inhalt	Größe cm	EAN
106534	blau/blue	18 L	32 x 20 x 33	4017166106534
106527	rot/red	18 L	32 x 20 x 33	4017166106527



ISOLIERTASCHE SOLE

Strapazierfähiges Polyester / aufgeschäumte Folie zum Isolieren, mit 2 Schultergurten und Reißverschluss

INSULATED BAG SOLE. Heavy duty polyester / foamed insulating foil, with 2 shoulder straps and zipper

Art.-Nr.	Farbe	Inhalt	Größe cm	EAN
106510	blau/blue	10 L	43 x 16 x 34,5	4017166106510
106503	rot/red	10 L	43 x 16 x 34,5	4017166106503





LICHTBOGENFEUERZEUG ARC

ELEKTRISCH

Hochwertiger Kunststoff, mit Lithium-Ionen-Akku, Zündung ohne Gas, sturmsicher, an USB-Schnittstellen aufladbar (~ 2 – 3 h), für je ca. 100 Zündungen, verdeckter Ein-/Aus-Schalter gegen unbeabsichtigtes Einschalten, mit Kontrolllampe für den Ladefortschritt, Sicherheitsabschaltung, inkl. USB-Kabel

LIGHTER ARC. High-quality plastics, electric, with lithium-ilon-accu, ignition without gas, windproof, rechargeable within 2 – 3 hours on USB interface, charge sufficient for up to 100 ignitions, hidden on-/off switch to prevent from accidental lighting, with control lamp for charging progress, safety switch-off, incl. USB-cord

Art.-Nr.	Länge cm	EAN
295801	20	4017166295801

STABFEUERZEUG RAINBOW

Metall matt verchromt / Soft-Grip-Einlage, einstellbare Flammenstärke, nachfüllbar

LIGHTER RAINBOW. Satin chromed metal / Soft-Grip insert, adjustable flame, refillable



Art.-Nr.	Länge cm	EAN
295160**	20	4017166295160

** Bei Abnahme von 12 Stück Lieferung im Verkaufsdisplay
When ordering 12 pieces delivery in display package

STABFEUERZEUG FLEXI TURBO

Hochwertiger Kunststoff, flexibler Stab, Sicherheitsflamme, sturmsicher, nachfüllbar, mit Kindersicherung

LIGHTER FLEXI TURBO. High-quality plastics, flexible shaft, fix flame, windproof, refillable, with child-proof lock

Art.-Nr.	Länge cm	EAN
295597 1	35	4022364494284
295610 2	35	4017166295610

1 Lieferung sortiert 16 Stück im Display: je 4 x blau, schwarz, silber, rot | Delivery assorted 16 pieces in display: 4 x each blue, black, silver, red
2 Lieferung sortiert 24 Blister im Display: je 6 x blau, schwarz, silber, rot | Delivery assorted 24 blister in display: 6 x each blue, black, silver, red

STABFEUERZEUG MIAMI TURBO

Hochwertiger Kunststoff, Sicherheitsflamme, sturmsicher, nachfüllbar, mit Kindersicherung

LIGHTER MIAMI TURBO. High-quality plastics, fix flame, windproof, refillable, with child-proof lock

Art.-Nr.	Länge cm	EAN
295627 2	30	4017166295627

2 Lieferung sortiert 24 Blister im Display: je 6 x grün, blau, rot, gelb | Delivery assorted 24 blister in display: 6 x each green, blue, red, yellow

GAS FÜR FEUERZEUGE

Butangas, zum Nachfüllen von Feuerzeugen und Crème Brûlée-Brennern

GAS FOR LIGHTER. Butan gas, to refill lighter and Crème Brûlée torches



Art.-Nr.	Inhalt	EAN
295634	Flasche à 90 ml 1	4017166295634
295542	Flasche à 300 ml 2	4017166295542

1 Bei Abnahme von 24 Stück Lieferung im Verkaufsdisplay | When ordering 24 pieces delivery package
2 Bei Abnahme von 12 Stück Lieferung im Verkaufsdisplay | When ordering 12 pieces delivery package

Es sind die
kleinen Dinge...

It's
the little things...

die aus einem Haus ein Zuhause machen – eine schöne Pflanze hier, ein interessanter Eyecatcher dort.

... that make a house a home - a beautiful plant here, an interesting eye-catcher there.

Zusammen mit einer Laterne entsteht im Handumdrehen ein Ensemble, das für sich spricht. Je nach Saison dekoriert oder gekonnt mit Strandgut aus dem letzten Urlaub in Szene gesetzt unterstreicht es die Individualität – mit **cilio** an Ihrer Seite.

Together with a lantern, you can create an ensemble in no time that speaks for itself. Decorated according to the season or stylishly arranged with beach findings from the last holiday, it underlines the individuality - with **cilio** by your side.

GISSKANNE FIORE

Edelstahl poliert, mit breitem Griff sowie langem und schmalen Ausgießer für zielgenaues Gießen

WATERING CAN FIORE. Stainless steel mirror polished, with wide handle as well as long and narrow spout for precise watering

Art.-Nr.	Inhalt	Ø	Höhe cm	EAN	
300031	1,5 L	13	22,5	4017166300031	





LATERNE VILLA

Edelstahl poliert/Glas, mit Tragegriff und Rauchabzug, GummifüÙe als Möbel- und Bodenschutz sowie für einen sicheren Stand, großzügige Tür zum Dekorieren (Lieferung ohne Kerze)
Für den Innen- und geschützten Außenbereich

LANTERN VILLA. stainless steel mirror polished/glass, with handle and smoke outlet, rubber feet for furniture and bottom protection as well as for the secure standing position, large door for easy decoration (delivery without candle)
For inside and protected outdoor areas

Art.-Nr.	Größe cm	EAN
293739	13 x 13 x 38	4017166293739
293661	16 x 16 x 50	4017166293661
293678	16 x 16 x 60	4017166293678
293685	16 x 16 x 70	4017166293685



LATERNE TORRE

Edelstahl poliert/Glas, mit Tragegriff und Rauchabzug, GummifüÙe als Möbel- und Bodenschutz sowie für einen sicheren Stand, großzügige Tür zum Dekorieren (Lieferung ohne Kerze)
Für den Innen- und geschützten Außenbereich

LANTERN TORRE. stainless steel mirror polished/glass, with handle and smoke outlet, rubber feet for furniture and bottom protection as well as for the secure standing position, large door for easy decoration (delivery without candle)
For inside and protected outdoor areas

Art.-Nr.	Größe cm	EAN
293715	11,5 x 11,5 x 31	4017166293715
293630	20 x 20 x 55	4017166293630
293647	20 x 20 x 65	4017166293647
293654	22 x 22 x 79	4017166293654



MINI-VENTILATOR *ventoforte*

Mit flexiblen Sicherheitsflügeln, aufklappbar für den Einsatz als Tischventilator, mit Trageriemen, inkl. 2 Batterien, Typ 1,5V (AA)

MINI FAN VENTOFORTE. With flexible safety wings, with carrying strap, incl. 2 batteries type 1,5V (AA)

Art.-Nr.	Höhe cm	EAN
190519**	11	4017166190519

** Bei Abnahme von 24 Stück Lieferung im Verkaufsdisplay
When ordering 24 pieces delivery in display package

TISCH-VENTILATOR VENTO

Metall hochglanzverchromt, Betrieb über USB-Schnittstellen, Ein-/Ausschalter, Schutzgitter, Neigungswinkel frei einstellbar, geräuscharmer Betrieb. 5V | 2,5 W

TABLE FAN VENTO. Chromed metal high glossy, operation by USB interfaces, on/off switch, tilt angle adjustable, runs quietly. 5V | 2,5 W

Art.-Nr.	Ø	Höhe cm	EAN
190403	14	15	4017166190403



MINI-VENTILATOR VENTOBOY FRIENDS

Mit flexiblen Sicherheitsflügeln, inkl. 2 Batterien, Typ 1,5V (AA)

MINI FAN VENTOBOY. With flexible safety wings, incl. 2 batteries type 1,5V (AA)

Art.-Nr.	Höhe cm	EAN
190557**	11	4017166190557

** Lieferung sortiert 12 Stück im Verkaufsdisplay: je 3 x Pirat, Königin, Cowboy, Polizist
Delivery assorted 12 pieces in display package: 3 x each pirate, queen, cowboy, policeman



MINI-VENTILATOR VENTOBOY FOOTBALL

Mit flexiblen Sicherheitsflügeln, inkl. 2 Batterien, Typ 1,5V (AA)

MINI FAN FOOTBALL. With flexible safety wings, incl. 2 batteries type 1,5V (AA)

Art.-Nr.	Höhe cm	EAN
190540**	11	4017166190540

** Bei Abnahme von 12 Stück Lieferung im Verkaufsdisplay
When ordering 12 pieces delivery in display package



MINI-VENTILATOR VENTOBOY CLASSIC

Mit flexiblen Sicherheitsflügeln, inkl. 2 Batterien, Typ 1,5V (AA)

MINI FAN VENTOBOY CLASSIC. With flexible safety wings, incl. 2 batteries type 1,5V (AA)

Art.-Nr.	Höhe cm	EAN
190564**	11	4017166190564

** Lieferung sortiert 12 Stück im Display: je 3 x rot, schwarz, grün, gelb
Delivery assorted 12 pieces in display: 3 x each red, black, green, yellow



MINI-VENTILATOR VENTOBOY TREND

Mit flexiblen Sicherheitsflügeln, inkl. 2 Batterien, Typ 1,5V (AA)

MINI FAN VENTOBOY TREND. With flexible safety wings, incl. 2 batteries type 1,5V (AA)

Art.-Nr.	Höhe cm	EAN
190595**	11	4017166190595

** Lieferung sortiert 12 Stück im Display: je 3 x lila, rosa, grau, blau
Delivery assorted 12 pieces in display: 3 x each purple, pink, grey, blue



MINI-VENTILATOR VENTOBOY CACTUS

Mit flexiblen Sicherheitsflügeln, inkl. 2 Batterien, Typ 1,5V (AAA)

MINI FAN VENTOBOY CACTUS. With flexible safety wings, incl. 2 batteries type 1,5V (AAA)

Art.-Nr.	Höhe cm	EAN
190588	11,5	4017166190588



MINI-VENTILATOR VENTOBOY FLAMINGO

Mit flexiblen Sicherheitsflügeln, inkl. 2 Batterien, Typ 1,5V (AAA)

MINI FAN VENTOBOY FKAMINGO. With flexible safety wings, incl. 2 batteries type 1,5V (AAA)

Art.-Nr.	Höhe cm	EAN
190571	13	4017166190571



SALES REPRESENTATIVES

AUSTRIA

Josef Senn
Schmiedgasse 7
A-6020 Innsbruck
Tel.: +43 512 342 040
Fax: +43 512 342 041
Mobil: +43 6 643 001 176
info@agentur-senn.at

BELGIUM

Deri Agenturen G.C.V.
Luc de Ridder
Bierbeekstraat 23
B-3001 Heverlee
Tel : +32 474 36 27 96
lucderidder.der@gmail.com

FRANCE

Plus Belle La Table SARL
Philippe Poncet
Les Belles Voies
F-14500 Roullours
Tel: +33 643 16 70 67
pponcet@live.fr

LUXEMBOURG

Christian Schnarrenberger
Höhscheider Weg 29
D-42699 Solingen
Tel.: +49 212 658 231
Fax: +49 212 658 233
c.schnarrenberger@cilio.de

NETHERLANDS

A.G. Kessler & Zn. v.o.f.
Vermogenweg 209
NL-3641 ST Mijdrecht
Tel.: +31 297 250 561
Fax: +31 297 284 837
info@kessler.nl
www.kessler.nl

GREAT BRITAIN

The Best Marketing Co Ltd
John Mabey
Valentine House
Enville 8, The Close
DY7 5HX South Staffordshire
Office: +44 13848 77439
john@bestmarketing-company.com

OUR PARTNERS

AUSTRALIA

Oppenheimer
Mark Campbell
5/107 Carnarvon Street
Silverwater NSW 2128 Australia
Tel: +61-2-9748-3111
Fax: +61-2-9648-3447
mcampbell@oppenheimer.com.au

BULGARIA

SIA Ltd.
Zona B-5; bl. 18, ap. 9
BG-1303 Sofia
Tel.: +35 929 206 217
Fax: +35 929 290 291
office@siabg.net

CYPRUS

Parousiasi Ltd.
L.Arh.Makariou C & Z Souza
1075 Lefkosia/Nicosia
Tel.: +30 2 109 478 130
Fax: +30 2 109 415 002
dnasi@sarafidisgroup.gr

CZECH REPUBLIC

Mobax CR s.r.o.
Suchbolska 782
CZ-25358 Horomerice
Tel.: +42 0233 920 408
Fax: +42 0233 920 411
mobax@mobaz.cz

FINLAND

Decanter Oy Ltd
Melkonkatu 24
FI -00210 Helsinki
Tel.: +35 8 505 771 306
Fax: +35 8 968 604 127
decanter@decanter.fi

GREECE

Cook-Shop Chain
Berson/ C. Sarafidis Bros. S.A.
GR-17675 Kalithea – Athen
Tel.: +30 23 109 928 472
Fax: +30 2 310 932 115
cookshop@sarafidisgroup.gr

ISRAEL

Malys H & M Ltd.
3 Hasadna st. Industrial Area
58814 Hulon
Tel.: +97 235 502 996
Fax: +97 235 501 107
haim@malys.co.il

ICELAND

Byggt og Buid ehf.
Olafur Már Hreinsson
Kringlunni 8-12
103 Reykjavik
Tel: 00354 5 689 400
Fax: 00354 5 889 293
Email: olafur@byggtogbuid.is

ITALY

Schönhuber SpA
Via J.G. Mahl 52
I-39031 Brunico
Tel.: +39 0 474 571 000
Fax: +39 0 474 571 099
info@schoenhuber.com

JORDAN

Irfan Tading Stores
Al-Sveifia, Yacoub Muammar
Str. 7
P.O. Box 5560
Amman
Tel.: +96 2065 811 170
Fax: +96 2065 821 200
info@irfanjo.com

KOREA

Hanway Trading Co., Ltd.
7th Floor of Hanway Building
65-7 Bangi-Dong, Songpa-Gu
413853 Seoul
Tel.: +82 24 193 110
hanway83@naver.com

MEXICO

Representaciones Albis,
S.A. de C.V.
Blvd. Hermanos Serdán No. 689 A
Col. San Rafael Poniente
C.P. 72029 Puebla, Pue.
Tel: +52 2228 915 731
Fax: +52 2228 915 733
info@albis.com.mx

NORWAY

Matec Maskiner AS
Welhavensvei 1
N-4319 Sandnes
Tel.: +47 51 526 580
Fax: +47 51 528 498
jone@matec.no
www.matec.no

PERU

Viewcorp S.A.C.
Av.Pardo y Aliaga 699-303B
27 San Isidro, Lima
Tel.: +51 14412 567
Fax: +51 14214 377
ron@viewcorp-trading.com

POLAND

FreeForm
Ul. Kobialka 60
03-044 Warschau
Tel.: +48 225 199 380
Fax: +48 225 199 381
janusz@freeform.com.pl

PORTUGAL

Lobena Lda.
Rua das Pedreiras, 345
Zona Ind. Sao Caetano
Vilar do Paraíso
P-4405-587 Vila Nova de Gaia
Tel.: +35 1227 115 821
Fax: +35 1227 115 579
Fax: +35 1227 115 861
lobena@lobena.pt

RUMANIA

Simona's Cookshop
Bd. Ion Mihalache nr. 98
Bl. 44A, Etaj 9, Ap. 26, Sector 1
Bucuresti
Tel.: 0040 733 054 247
simona@almarom.ro

RUSSIA

MSW Aussenhandel
Swetlana Maisinger
Hauptstraße 63
D- 65462 Ginsheim-Gustavsburg
Tel: +49 1749 990 054
a.maisinger@wollkraft.de

SLOVENIA

RUBICO TRADE D.O.O.
Smrekarjeva 1
3000 Celje
Tel.: +03 4907 002
Fax: +03 953 001
tina.span@rubico-trade.si

SOUTH AFRICA

Stainless Steel Solutions T/A
KRDM Innovative Homeware
Kolja Stürmer
93a Kyalami Drive, Killarney
Gardens
ZA-7441 Captown
Tel: +27 21 556 3454
kolja@krdm.co.za
www.krdm.co.za

SPAIN

Home Solutions Bcn 21, S.L.
Monica Guitarte
C/Garriga, 82
E-08912 Badalona
Tel: +34-93-889 38 80
monica@homesolutionsbcn.com

SWEDEN

Berg & Nycander AB
Box 107
S-17822 Ekeröe
Tel.: +46 856 031 070
Fax: +46 856 031 565
caroline@bony.se

SWITZERLAND

Mayer & Bosshardt AG
Riehenring 175/2. Stock
CH-4058 Basel
Tel.: +41 616 909 730
Fax: +41 616 909 731
bosshardt@mbag.ch

UNITED ARAB EMIRATES

4 Homes FZ Co.
P.O. Box 62688
Dubai
Tel.: +97 148 813 383
Fax: +97 1488 173 393
nazia@4homes.ae

URUGUAY

Impex International S.A.
Marcelino Sosa 2326
11800 Montevideo
Tel.: +59 822 082 972
impex@redfacil.com.uy

USA

Frieling USA, Inc.
The Frieling Building
398 York Southern Rd
Fort Mill, SC 29715-7715
Tel.: ++803 548 2000
Fax: ++803 548 2060
mfs@frieling.com
www.frieling.com

KONTAKT/CONTACT

GESCHÄFTSFÜHRER / MANAGING DIRECTOR

Stefan Schmitz
Björn Weißmeier-Dörste

VERKAUFSLEITUNG

Werner Spedale

VERKAUF / BÜRO

Kordula Schmidt
Anja Frenz
Nicole Ernst

Tel. +49 (0) 212 / 6 582 50

Fax +49 (0) 212 / 6 582 59

e-mail verkauf@cilio.de

EXPORT MANAGER

Claudia Kaldasch

EXPORT SALES

Maria Romano
Tobias Elzemann
Dorothee Picard

Tel. +49 (0) 212 / 6 582 62

Fax +49 (0) 212 / 6 582 26

e-mail export@cilio.de

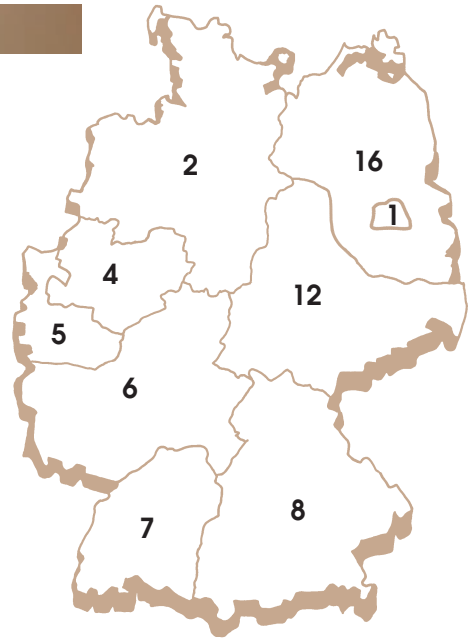

GEBIET 1

Berlin

BERNHARD ZAWADZKI
Mühlenstr. 6
34346 Hannoversch Münden

Telefon: 05 541 / 955 872
Fax: 05 541 / 955 757
Mobil: 0 178 / 8 080 560
b.zawadzki@cilio.de

GEBIET 2

Schleswig-Holstein, Bremen,
Hamburg, Niedersachsen

BERNHARD ZAWADZKI
Mühlenstr. 6
34346 Hannoversch Münden

Telefon: 05 541 / 955 872
Fax: 05 541 / 955 757
Mobil: 0 178 / 8 080 560
b.zawadzki@cilio.de

GEBIET 4/5

Nordrhein-Westfalen,
Teile von Niedersachsen

HOLGER LOHSE
Eischeider Str. 36 a
53819 Neunkirchen-Seelscheid

Telefon: 02 247 / 9 000 159
Fax: 02 247 / 9 000 739
Mobil: 0 172 / 2 486 127
h.lohse@cilio.de

GEBIET 6

Hessen, Rheinland Pfalz,
Saarland

KLAUS KATZMARZIK
Burgstr. 9
35444 Biebertal

Telefon: 06 409 / 804 770
Fax: 06 409 / 804 769
Mobil: 0 172 / 2 662 511
k.katzmarzik@cilio.de

GEBIET 7

Baden Württemberg

ab 01.04.2019 **JÜRGEN STROHM**
Ahornweg 47
72535 Heroldstatt

Telefon: 07 389 / 90 60 04
Fax: 07 389 / 16 55
Mobil: 0 171 / 2 14 33 53
j.strohm@cilio.com

GEBIET 8

Bayern

SAMUEL BLATTMANN
Thanellerstr. 15
86163 Augsburg

Telefon: 08 21 / 2 623 331
Fax: 08 21 / 2 623 330
Mobil: 0 176 / 86 121 488
s.blattmann@cilio.de

ANDREA BLATTMANN

Mobil: 0 171 / 7 907 569

GEBIET 12

Thüringen, Sachsen,
Sachsen-Anhalt

MARKO HEIM
Untere Hauptstr. 29
09244 Niederlichtenau

Telefon: 037 208 / 88 898
Fax: 037 208 / 88 897
Mobil: 0 177 / 2 341 956
m.heim@cilio.de

GEBIET 16

Mecklenburg-Vorpommern,
Brandenburg

MARKO HEIM
Untere Hauptstr. 29
09244 Niederlichtenau

Telefon: 037 208 / 88 898
Fax: 037 208 / 88 897
Mobil: 0 177 / 2 341 956
m.heim@cilio.de

B

Bag clips	16
Bar set	95
Bar strainer	94
Boston shaker	95
Bottle cooling bag	104
Bottle stopper	101
Butter dish	72
Butter knife	72

C

Canister	73
Canteen flask	47, 112
Champagne stopper	101
Cheese grater	69
Cheese hatchet	68
Cheese knife	66 - 68
Cheese-party raclette	98
Cheese slicer	68
Chocolate fondue	79
Chocolate fountain	79
Chili mill	58
Cooling cubes	92
Cooling sleeve	104
Cooling stones	92
Corkscrew	98, 100
Cruet set	59, 60
Cups	38, 39
Cutlery organizer	73
Cappuccino cup	38, 39
Cappuccino spoon	40
Cocktail shaker	95
Cocktail spoon	92
Coffee filter	29 - 33
Coffee filter station	27
Coffee glass	41
Coffee measure	17, 31
Coffee maker	15
Coffee mill	16, 31
Coffee pot	33
Cooking spoon	63
Cow milk jug	42

D

Decanter	103
Decanting funnel	103
Decanting pourer	103
Decorating dredger	25
Dredger	25, 43, 59, 60
Drinking straws	94
Drip Catcher	100
DRIP-MASTER	27
Drop Stop	102

E

Egg boiler	81
Egg cup	72
Egg spoon	72
Espresso cup	38, 39
Espresso glass	41
Espresso knock box	16
Espresso maker	9 - 14
Espresso mill	16
Espresso mug	40
Espresso spoon	40
Espresso tamper	17

F

Fan	120, 121
Foam cup	24
Foil cutter	100
Food container	51, 112
Food glass	75
FORMAGGIO	64 - 69
French press	18 - 20
Fruit basket	73

G

Gas for lighter	116
Glass marker	96

H

Hip flask	96
Hour glass	77
Honey server	63, 73
Hotplate	16

I

Ice crusher	96
Ice cube tray	92
Insulated bag	113 - 115
Insulated backpack	112
Insulated jug	44, 45
Insulated bottle	45 - 47
Insulated drinking bottle	47, 49
Insulated drinking mug	50

J

Jigger	94
Jug	33, 44, 45
Juicer	82, 85 - 89

K

Knock box	16
-----------	----

L

Lantern	118, 119
Latte Macchiato glass	41
Latte Macchiato jug	25
Latte Macchiato spoon	40
Lemon juice pourer	96
Lighter	116
Limescale catcher	34
Lunch box	51

M

Milk and sugar dispenser	42
Milk coffee cup	38
Milk coffee glass	41
Milk frother	21 - 23
Milk jug	24, 42
Milk thermometer	25
Mill	16, 31, 55 - 58
Mini fan	120, 121
Mini hotplate	16
Mini table cleaner	76
Mortar	53
Moscow Mule mug	93

N		T	
Napkin holder	74	Table bell	76
Napkin rings	74	Table fan	120
Nut cracker	70, 71	Table top cleaner	76
Nutmeg mill	58	Table waste bin	76
		Thermometer	25
		Toaster	81
		TOSCANA	63
O		Tray	43
Oil bottle	61	Timer	77
Oil drizzler	61	Toothpick dispenser	74
		Turkish coffee maker	15
		Turner	63
P			
Pepper mill	55 - 58	W	
Pestle for Caipirinha	94	Waiter´s knife	100
Permanent filter	32	Warmer	33
Picnic basket	106 - 110	Water carafe	90
Picnic blanket	111	Water kettle	29, 34 - 35, 80
Pomegranate juicer	85	Watering can	117
Pourer	60, 96, 103	Wine cap	101
Pour-over water kettle	29	Wine cooler	104
Pot	33	Wine pourer	103
Professional juicer	85 - 89	Wine pump	101
		Wine set	99
		Wok turner	63
S			
Salad set	63		
Salt mill	55 - 58		
Serving board	65		
Serving platter	64, 65		
Serving tray	43		
Shaker	43, 59, 60		
Smoothie maker	82		
Spoon	40, 63, 72, 94		
Storage container	64		
Storage jars	55		
Sugar canister and milk jug	42		
Sweetener dispenser	43		

A

aerolatte	22 - 23, 25
Ausschlagdose	16
Aufschäumbecher	24
Aufschäumer	21 - 23
Ausgießer	60, 96, 103

B

Barmaß	94
Bar Set	95
Barsieb	94
Becher	40, 93
Besteckkasten	73
Boston Shaker	95
Butterdose	72
Buttermesser	72

C

Caffenu	36, 37
Caipirinha-Stößel	94
Cappuccino Creamer	21 - 23
Cappuccinolöffel	40
Cappuccinotasse	38, 39
Champagnerverschluss	101
Chilimühle	58
Cocktailöffel	92
Cocktailshaker	95

D

Dauerfilter	32
Dekanter	103
Dekantierausgießer	103
Dekantiertrichter	103
Dekorierschablonen	25
Dekorierstreuer	25
Speisenglas	75
DRIP-MASTER	27
DROPSTOP	102

E

Eierbecher	72
Eierkocher	81
Eierlöffel	72
Eiswürfelform	92
Entkalker	37
Espresso-Ausschlagdose	16
Espressobecher	40
Espressodrücker	17
Espresso-Glas	41
Espressokocher	9 - 14
Espressolöffel	40
Espressomühle	16
Espressotasse	38, 39

F

Flaschenkühltasche	104
Flaschenverschluss	101
Feldflasche	47, 112
Feuerzeug	116
Feuerzeuggas	116
Flüssigentkalker	37
Folienschneider	100
Food Container	51, 112
FORMAGGIO	64 - 69
French Press	18 - 20

G

Gas für Feuerzeuge	116
Gießkanne	117
Glasmarker	96
Granatapfelpresse	85

H

Honigportionierer	63, 73
-------------------	--------

I

Ice Crusher	96
Isolierkanne	44, 45
Isolierflasche	45 - 47
Isoliertasche	113 - 115
Isoliertrinkbecher	50
Isoliertrinkflasche	47, 49

K

Kaffeebereiter	18 - 20
Kaffeefilter	29 - 33
Kaffee-Filterstation	27
Kaffee-Glas	41
Kaffeekanne	33
Kaffeelot	17, 31
Kaffeemühle	16, 31
Kaffeetütenklammern	16
Kalkfänger	34
Kannen	33, 44, 45
Käsebeil	68
Käsehobel	68
Käsemesser	66 - 68
Käse-Party Raclette	69
Käsereibe	69
Käseschneider	68
Kellnermesser	100
Kochlöffel	63
Kochplatte	16
Korkenzieher	98, 100
Kühlmanschette	104
Kühlschrank-Butterdose	72
Kühltaschen-Rucksack	112

L

Laterne	118, 119
Latte Macchiato-Glas	41
Latte Macchiato-Kännchen	25
Latte Macchiato-Löffel	40
Lichtbogenfeuerzeug	116
Löffel	40, 63, 72
Lunch Box	51

M		S		W	
Matcha – Quirl	23	Saftpresse	82, 85 - 89	Wasserkaraffe	90
Menage	59, 60	Salzmühle	55 - 58	Wasserkocher	29, 34, 80
Milchaufschäumer	21 - 23	Salatbesteck	63	Wasserkessel	34 - 35
Milchkaffee-Glas	41	Sanduhr	77	Weinkühler	104
Milchkaffeetasche	38	Schokoladenfondue	79	Weinausgießer	103
Milchkanne	24	Schokoladenbrunnen	79	Wein-Set	99
Milchkännchen	42	Servierbrett	65	Weinpumpe	101
Milchkuh	42	Servierplatte	64, 65	Weinverschluss	101
Milchthermometer	25	Serviertablett	43	Wender	63
Milch- und Zuckerspender	42	Serviettenhalter	74	Wok-Wender	63
Mini Kochplatte	16	Serviettenringe	74		
Mini Tischsauger	76	Smoothie Maker	82		
Mini-Ventilator	120, 121	Speisenglas	75	Z	
Mokka-Kocher	15	Stabfeuerzeug	116	Zahnstocherspender	74
Mörser	53	Stövchen	33	Zitronensaft-Ausgießer	96
Moscow Mule Becher	93	Stößel für Caipirinha	94	Zuckerdose	42
Mühle	16, 31, 55 - 58	Streuer	25, 43, 59, 60	Zuckerspender	42
Muskatmühle	58	Süßstoffspender	43		
N		T			
Nussknacker	70, 71	Tablett	43		
		Taschenflasche	96		
		Tassen	38, 39		
O		Timer	77		
Obstkorb	73	Tischabfalleimer	76		
Ölflasche	61	Tischkehrer	76		
Ölkanne	61	Tischklingel	76		
		Tischsauger	76		
		Tisch - Ventilator	120		
P		Thermometer	25		
Pfeffermühle	55 - 58	Toaster	81		
Picknick-Decke	111	TOSCANA	63		
Picknick-Korb	106 - 110	Trinkhalme	94		
Profi-Saftpresse	85 - 89	Tropfenfänger	100		
		Türkisch Mokka-Kocher	15		
		Tütenklammern	16		
Q					
Quirl Matcha	23	V			
		Ventilator	120, 121		
R		Vorratsdose	64, 73		
Rechaud	33	Vorratsgläser	55		
Reinigungskapseln	37				
Rührlöffel	63				

cilio

tisch-accessoires GmbH

Höhscheider Weg 29, D-42699 Solingen
Tel. (02 12) 65 82 50, Fax (02 12) 65 82 59
e-mail: verkauf@cilio.de
www.cilio.de